

Designböden

Design flooring / Sols design / Pavimenti vinilici modulari LVT



LOOK
BOOK
2019 – 2022

INKU

Traumhaft schöne Böden!

Die Produktvielfalt von natürlich schönen INKU Designböden ist schier unendlich. Wer hier die Wahl hat, hat die Qual. Für jeden Geschmack und Einrichtungsstil ist etwas Passendes dabei. Jede RAUMWELT hat ihre reizvollen Böden. Lassen Sie sich inspirieren und finden Sie Ihren ganz persönlichen Lieblingsboden.

There is almost no end to the variety of products of INKU beautiful design flooring. You will simply be spoilt for choice. There is something to suit every taste and furnishing style. Each RAUMWELT has its attractive floors, so let us inspire you and find your own personal favourite floor.

La gamme des splendides sols design INKU est quasi illimitée. Qui a le choix a ... l'embarras du choix ! Il y en a pour tous les goûts et tous les styles. Chaque RAUMWELT trouve à s'accorder de façon optimale à l'un des sols. Laissez libre cours à votre inspiration et choisissez le sol qui correspond exactement à vos préférences.

La varietà della straordinaria bellezza dei pavimenti in laminato INKU è quasi infinita. Sarà duro scegliere. Troverete qualcosa di adatto a tutti i gusti e a ogni stile di arredamento. Per ogni RAUMWELT esiste un pavimento. Lasciatevi ispirare e troverete il vostro pavimento preferito.



Ihre
Steffi Böhler





Inhaltsverzeichnis

Contents / Table de matières / Indice

555

2,5 mm Klebevariante

Adhesive version / Variante encollée / Variante adesiva

Dekor Name	Fläche Seite
5201 Country Grey Oak	92
5202 Brown Driftwood	91
5203 Urban Grey Oak	49
5204 Brown Cracked Oak	46
5205 French Blond Oak	60
5206 Sawn Sugar Oak	31
5207 Incredible Light Oak	11
5208 Incredible Classic Oak	67
5209 Incredible Dark Oak	78
5210 Crystal Stone	93
5301 Perfect Sugar Oak	40
5302 Perfect Sand Oak	41
5303 Perfect Grey Oak	35
5304 Perfect Tanned Oak	43
5305 Perfect Beige Oak	8
5306 Perfect Brown Oak	68
5307 Perfect Natural Oak	9
5308 Perfect Ivory Oak	42
5407 Blond Pine	65
5408 Wild Maple	73
5410 Misty Oak	47
5412 Cozy Oak	63
5413 Bleached Elm	44
5414 Wild Oak	75
5415 Travertine	25
5416 Black Slate	18
5418 Metalstone Night	14
5424 Imperial Oak	72
5425 African Grey Oak	36
5433 Cloudy Oak	50
5434 Eclipse Oak	51
5442 Rusty Metal	28
5443 Black Screed	79
5444 Grey Screed	12
5452 Classic Fir	58
5453 Country Blond Pine	80
5454 Brown Nuttree	76
5455 Light Tetris Wood	81
5456 Dark Tetris Wood	84
5457 Brown Tetris Wood	83
5458 Mixed Ornament	85
5459 Old Patch blue	88
5460 Old Patch beige	89
5461 Old Patch grey	90
5462 Splash Stone	29
5463 Urban Concrete	13
5464 Black Big Stone	19
5465 Dark Big Stone	16
5466 Beige Big Stone	22

555 Click!

5,0 mm Clickversion

Click version / Version cliquée / Versione clic

Dekor Name	Fläche Seite	Dekor Name	Fläche Seite	Dekor Name	Fläche Seite
407P Blond Pine	65	5467 Light Big Stone	24	407P Blond Pine	65
408P Wild Maple	73	5501 Creamy Maple	59	408P Wild Maple	73
410P Misty Oak	47	5504 Cottage Oak	77	410P Misty Oak	47
412P Cozy Oak	63	5508 Champagne Oak	10	412P Cozy Oak	63
413P Bleached Elm	44	5509 Spring Oak	45	413P Bleached Elm	44
414P Wild Oak	75	5511 Wormy Light Oak	62	414P Wild Oak	75
415P Travertine	25	5513 Ivory Elm	37	415P Travertine	25
416P Black Slate	18	5514 Hickory	57	416P Black Slate	18
418P Metalstone Night	14	5515 Arctic Oak	32	418P Metalstone Night	14
424P Imperial Oak	72	5517 Yellow Sawn Cut	52	424P Imperial Oak	72
425P African Grey Oak	36	5518 Grey Driftwood	38	425P African Grey Oak	36
434P Eclipse Oak	51	5524 Honey Oak	69	434P Eclipse Oak	51
459P Old Patch blue	88	5525 Purple Larch	56	459P Old Patch blue	88
463P Urban Concrete	13	5528 Wormy Grey Fir	53	463P Urban Concrete	13
468P Perfect Sugar Oak	40	5529 Rustic Grey Oak	48	468P Perfect Sugar Oak	40
469P Perfect Sand Oak	41	5530 White Sawn Cut	33	469P Perfect Sand Oak	41
470P Perfect Grey Oak	35	5531 Sandy Oak	34	470P Perfect Grey Oak	35
471P Perfect Tanned Oak	43	5532 Natural Fir	61	471P Perfect Tanned Oak	43
472P Perfect Beige Oak	8	5533 Dark Concrete	15	472P Perfect Beige Oak	8
473P Perfect Brown Oak	68	5534 Light Concrete	23	473P Perfect Brown Oak	68
474P Perfect Natural Oak	9	5535 Metal Plate	30	474P Perfect Natural Oak	9
475P Incredible Light Oak	11	5536 Natural Concrete	26	475P Incredible Light Oak	11
476P Incredible Classic Oak	67	5537 Metallic Slate	17	476P Incredible Classic Oak	67
477P Incredible Dark Oak	78			477P Incredible Dark Oak	78
478P Spring Oak	45			478P Spring Oak	45

Technische Daten

Technical data / Caractéristiques techniques / Dati tecnici

555 – 2,5 mm Klebevariante **174**
Adhesive version / Variante encollée / Variante adesiva

555 – 5,0 mm Clickversion **175**
Click version / Version cliquée / Versione clic

Verlege- und Pflegeanleitungen finden Sie auf:

For fitting instructions and maintenance instructions, see: / Vous trouverez les instructions de pose et les conseils d'entretien sur notre site: / Le istruzioni di installazione e manutenzione sono disponibili all'indirizzo:

www.joka-servicebox.de / www.inku-servicebox.de

555 XXL

2,5 mm Klebevariante

Adhesive version / Variante encollée / Variante adesiva

Dekor Name	Fläche Seite
9623 Beach Oak	96
9624 Celtic Oak	97
9625 Western Oak	98
9626 Royal Oak	99
9627 Caramel Oak	100
9628 Viking Oak	101
9629 Brown Mixed Oak	102
9630 Fog Oak	103

555 XXL Click!

5,0 mm Clickversion

Click version / Version cliquée / Versione clic

Dekor Name	Fläche Seite
9623 Beach Oak	96
9624 Celtic Oak	97
9625 Western Oak	98
9626 Royal Oak	99
9627 Caramel Oak	100
9628 Viking Oak	101
9629 Brown Mixed Oak	102
9630 Fog Oak	103

Technische Daten

Technical data / Caractéristiques techniques / Dati tecnici

555 XXL – 2,5 mm Klebevariante **176**

Adhesive version / Variante encollée / Variante adesiva

555 XXL – 5,0 mm Clickversion **177**

Click version / Version cliquée / Versione clic

330

2,0 mm Klebevariante

Adhesive version / Variante encollée / Variante adesiva

Dekor Name	Fläche Seite
2806 Grey Slate	168
2808 Ivory Elm	137
2809 Grey Mixed Oak	142
2811 Airy Oak	133
2812 Pure Oak	129
2814 Antique Oak	146
2816 Wild Oak	125
2817 Light Oak	122
2818 Blond Beech	123
2819 Creamy Maple	121
2821 Flamy Aspen	124
2823 Vanilla Oak	118
2824 Wormy Light Oak	114
2825 Wild Pine	120
2827 Sky Oak	108
2830 Old Spruce	141
2832 Highland Oak	143
2833 Waxed Oak	132
2834 Grey Pine	136
2835 White Limed Oak	109
2837 Bourbon Spruce	147
2839 Barrel Pine	149
2840 Old Grey Oak	140
2842 Hickory	150
2844 Travertine	159
2845 Dark Concrete	163
2847 Metallic Slate	160
2848 Stormy Oak	112
2849 Scandinavian Pine	113
2850 Iceland Ash	114
2851 Milky Maple	115
2852 Summer Maple	116
2853 Worn Ash	117
2854 Fresh Oak	126
2855 Golden Pine	127
2856 Vintage Timber	128
2857 Classic Nuttree	148
2858 Dark Moonstone	151
2859 Light Moonstone	152
2860 Dark Limed Oak	153
2861 Washed Brown Pine	156
2862 Treated Maple	157
2863 Brown Limed Oak	158
2864 Dark Silver Stone	161
2865 Bright Concrete	162
2866 Grey Washed Stone	164
2867 Light Washed Stone	165
2868 Rustic Brown Stone	166
2869 Rusty Stone	167

330 Click!

4,5 mm Clickversion

Click version / Version cliquée / Versione clic

Dekor Name	Fläche Seite
812P Pure Oak	129
814P Antique Oak	146
823P Vanilla Oak	118
824P Wormy Light Oak	119
832P Highland Oak	143
833P Waxed Oak	132
834P Grey Pine	136
835P White Limed Oak	109
839P Barrel Pine	149
840P Old Grey Oak	140
845P Dark Concrete	163
847P Metallic Slate	160
849P Scandinavian Pine	113
851P Milky Maple	115
852P Summer Maple	116
853P Worn Ash	117
854P Fresh Oak	126
855P Golden Pine	127
857P Classic Nuttree	148
860P Dark Limed Oak	153
863P Brown Limed Oak	158
865P Bright Concrete	162
866P Grey Washed Stone	164
867P Light Washed Stone	165

Technische Daten

Technical data / Caractéristiques techniques / Dati tecnici

330 – 2,0 mm Klebevariante **178**

Adhesive version / Variante encollée / Variante adesiva

330 – 4,5 mm Clickversion **179**

Click version / Version cliquée / Versione clic



5525 Purple Larch

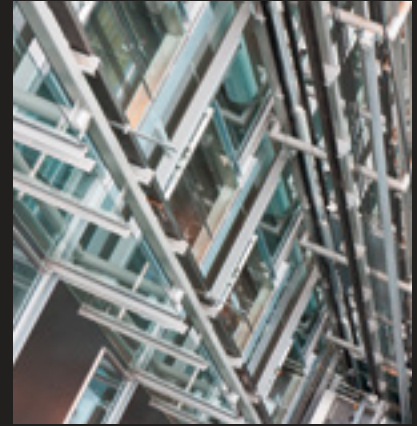

VIELFÄLTIGE
DIMENSIONEN

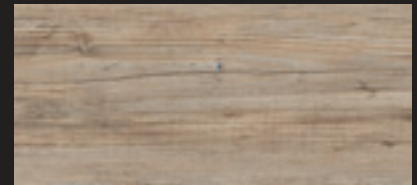

5518 Grey Driftwood

SPANNENDE
OPTIKEN

LANGLEBIG &
ROBUST



5424 / 424P **Click!** Imperial Oak



Designböden 555

Design flooring / Sols design / Pavimenti vinilici modulari LVT

Vorteile

Advantages / Avantages / Vantaggi



Bewährte Klebevariante

- **geringe Aufbauhöhe**
*low construction height /
montage sur une faible épaisseur /
altezza di costruzione ridotta*
- **einfacher Plankenaustausch**
*easy to replace boards /
remplacement aisé d'un panneau /
facile sostituzione delle tavole*
- **für Feuchträume geeignet**
*suitable for most environments /
compatible milieu humide /
adatto per ambienti umidi*



Clickversion mit Pro Connect-Technologie

- **schnelle & saubere Verlegung**
*fast and clean installation /
pose rapide et propre /
installazione rapida e pulita*
- **starke Verbindungen**
*stable connections /
connexions stables /
connessioni resistenti*
- **Maß- und Dimensionsstabilität**
*dimensional stability /
stabilité dimensionnelle /
stabilità delle dimensioni e delle misure*

Designböden 555 5305 / 472P Perfect Beige Oak



max. 27°C Typ W

Passende Sockelleiste
EI 36
FO 660 foliert
2400 mm



Dimensionen
22,86 x 150,00 cm / 2,5 mm
Dimensionen *Click!*
17,78 x 121,28 cm / 5,0 mm

Designböden 555 5307 / 474P Perfect Natural Oak



Passende Sockelleiste
EI 680
FO 660 foliert
2400 mm



Dimensionen
22,86 x 150,00 cm / 2,5 mm
Dimensionen *Click!*
17,78 x 121,28 cm / 5,0 mm

Designböden 555 5508 Champagne Oak



Passende Sockelleiste
EI 163
FO 660 foliert
2400 mm



Dimensionen
18,42 x 121,92 cm / 2,5 mm

Designböden 555 5207 / 475P Incredible Light Oak















Passende Sockelleiste
EI 547
FO 660 foliert
2400 mm



Dimensionen
18,50 x 150,50 cm / 2,5 mm
Dimensionen *Click!*
17,78 x 121,28 cm / 5,0 mm

Designböden 555 5444 Grey Screed













Passende Sockelleiste
WS 10
FO 660 foliert
2400 mm



Dimensionen
45,72 x 91,44 cm / 2,5 mm

Designböden 555 5463 / 463P Urban Concrete



max. 27°C Typ W











Passende Sockelleiste
WS 10
FO 660 foliert
2400 mm



Dimensionen
45,72 x 91,44 cm / 2,5 mm
Dimensionen *Click!*
45,08 x 90,80 cm / 5,0 mm

Designböden 555 5418/418P Metalstone Night



				
max. 27°C	Typ W		GARANTIE 15 Jahre Wohnbereich	GARANTIE 5 Jahre Gewerblich
				

Passende Sockelleiste
WS 10
FO 660 foliert
2400 mm



Dimensionen
30,48 x 60,96 cm / 2,5 mm
Dimensionen *Click!*
29,84 x 60,32 cm / 5,0 mm

Designböden 555 5533 Dark Concrete



Passende Sockelleiste
WS 10
FO 660 foliert
2400 mm



Dimensionen
45,72 x 45,72 cm / 2,5 mm

Designböden 555 5465 Dark Big Stone



Passende Sockelleiste
WS 10
FO 660 foliert
2400 mm



Dimensionen
100,00 x 100,00 cm / 2,5 mm

Designböden 555 5537 Metallic Slate



max. 27°C Typ W













Passende Sockelleiste
WS 10
FO 660 foliert
2400 mm



Dimensionen
30,48 x 60,96 cm / 2,5 mm

Designböden 555 5416 / 416P Black Slate



				
max. 27°C	Typ W		15 Jahre Wohnbereich	5 Jahre Gewerblich
				
		B ₁₁ -s1	DS	
				
				

Passende Sockelleiste
WS 10
FO 660 foliert
2400 mm



Dimensionen
30,48 x 60,96 cm / 2,5 mm
Dimensionen *Click!*
29,84 x 60,32 cm / 5,0 mm

Designböden 555 5464 Black Big Stone



Passende Sockelleiste
WS 10
FO 660 foliert
2400 mm



Dimensionen
100,00 x 100,00 cm / 2,5 mm





Designböden 555
5464 Black Big Stone
Teppichböden Trend/Atlantis | Locarno 120
Wohnstoffe | Relievo 218 049 078
Tapeten Carat | Nr. 17643

Raumwelt Lebendige Vielfalt

Designböden 555 5466 Beige Big Stone

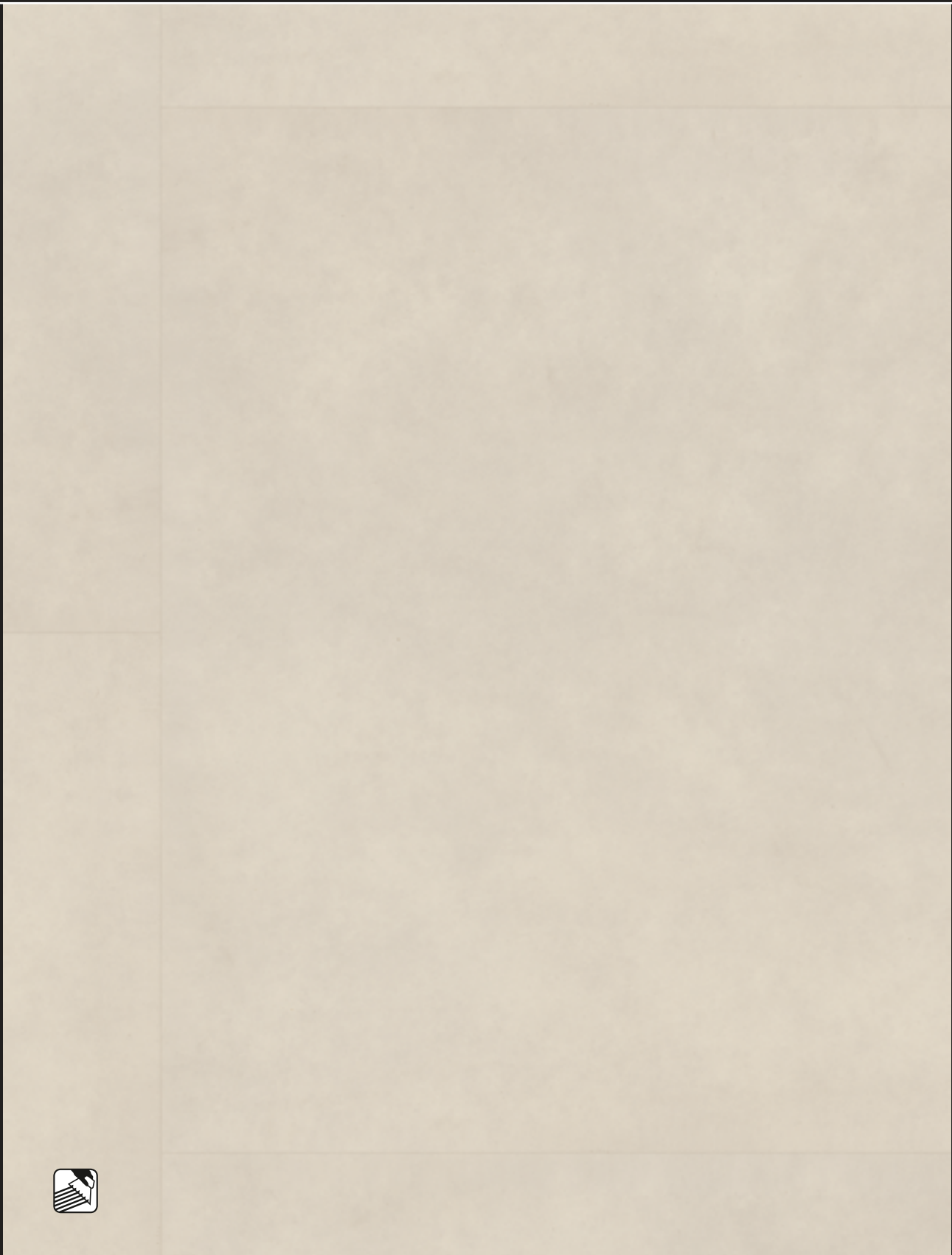

max. 27°C	Typ W			

Passende Sockelleiste
WS 10
FO 660 foliert
2400 mm



Dimensionen
100,00 x 100,00 cm / 2,5 mm

Designböden 555 5534 Light Concrete

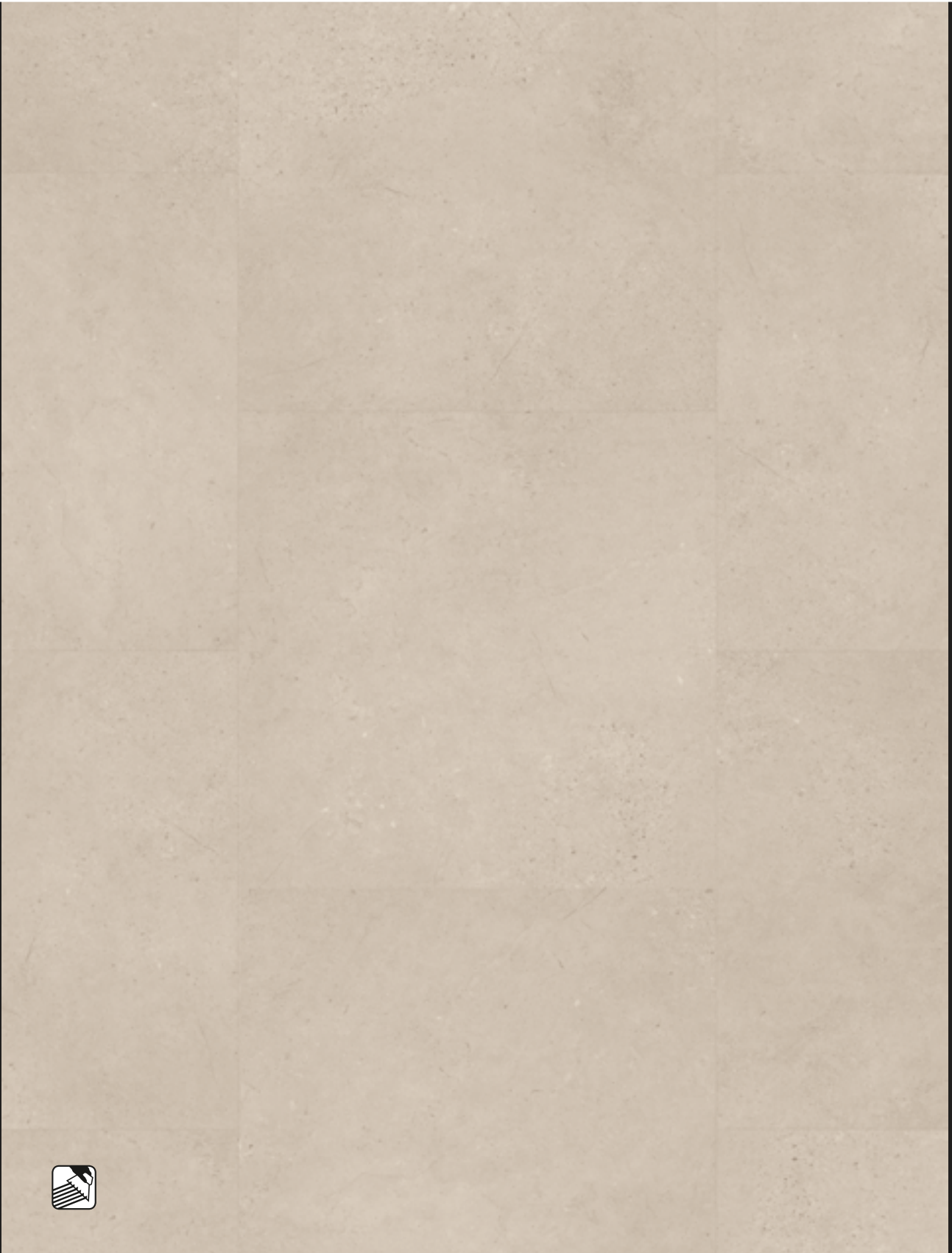

Passende Sockelleiste
WS 10
FO 660 foliert
2400 mm



Dimensionen
45,72 x 45,72 cm / 2,5 mm

Designböden 555 5467 Light Big Stone

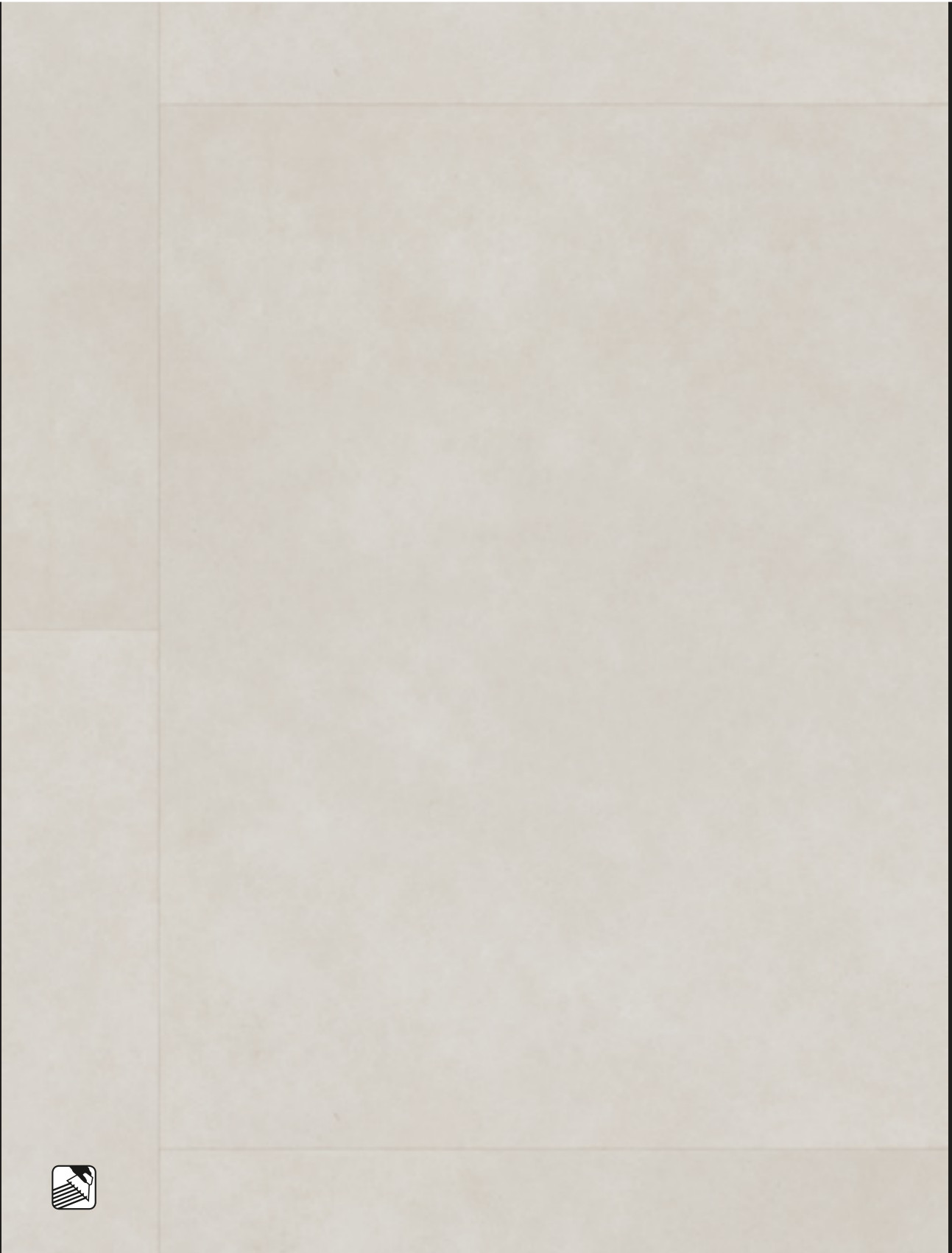

max. 27°C Typ W











Passende Sockelleiste
WS 10
FO 660 foliert
2400 mm



Dimensionen
100,00 x 100,00 cm / 2,5 mm

Designböden 555 5415/415P Travertine



max. 27°C Typ W

Passende Sockelleiste
WS 10
FO 660 foliert
2400 mm



Dimensionen
30,48 x 60,96 cm / 2,5 mm
Dimensionen *Click!*
29,84 x 60,32 cm / 5,0 mm

Designböden 555 5536 Natural Concrete

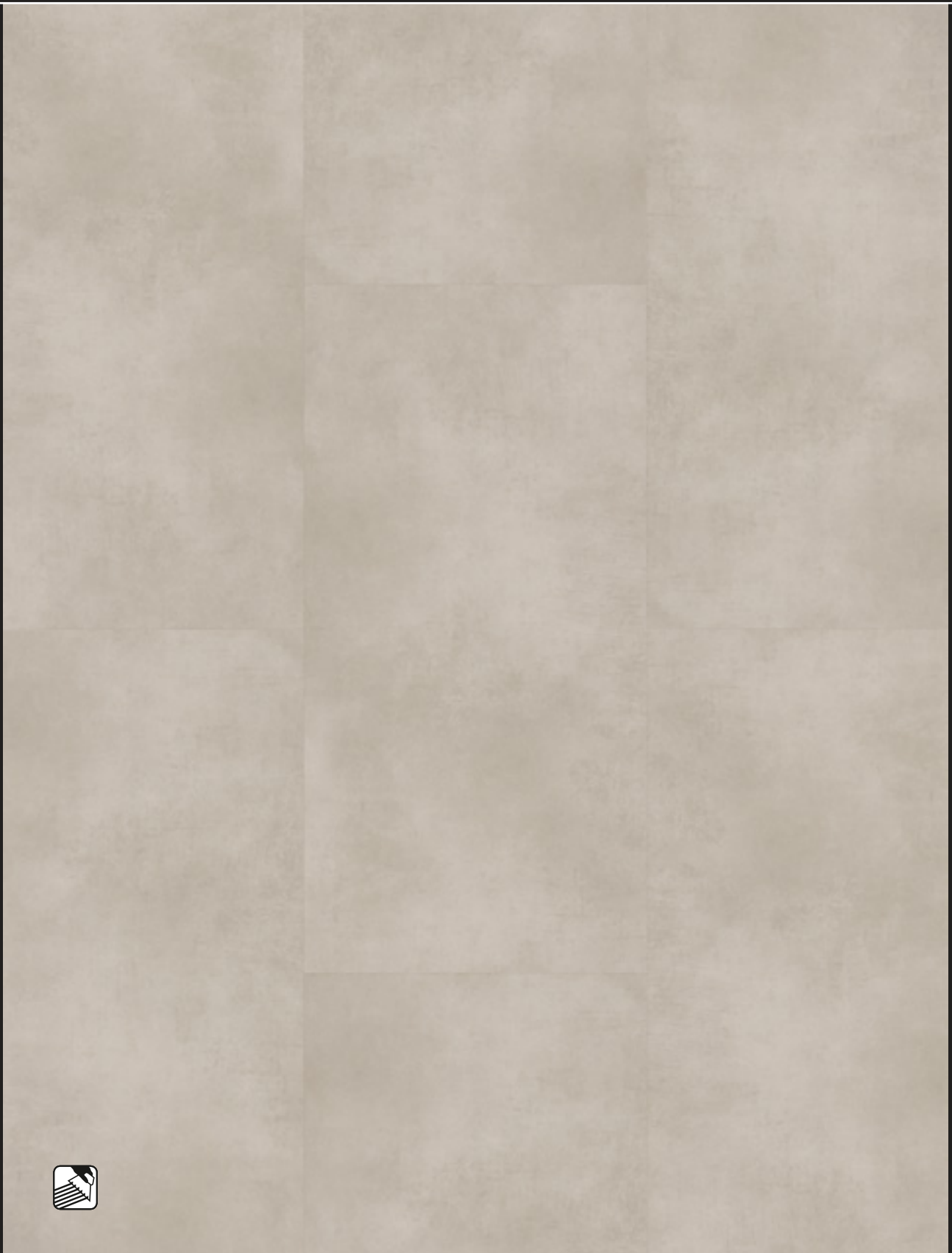

Passende Sockelleiste
WS 10
FO 660 foliert
2400 mm



Dimensionen
45,70 x 91,40 cm / 2,5 mm



Designböden 555
5536 Natural Concrete

Raumwelt Lebendige Vielfalt

Designböden 555 5442 Rusty Metal



Passende Sockelleiste
WS 10
FO 660 foliert
2400 mm



Dimensionen
45,72 x 91,44 cm / 2,5 mm

Designböden 555 5462 Splash Stone



Passende Sockelleiste
WS 10
FO 660 foliert
2400 mm



Dimensionen
45,72 x 91,44 cm / 2,5 mm

Designböden 555 5535 Metal Plate



Passende Sockelleiste
WS 10
FO 660 foliert
2400 mm



Dimensionen
45,70 x 91,40 cm / 2,5 mm

Designböden 555 5206 Sawn Sugar Oak



			GARANTIE 15 Jahre Wohnbereich	GARANTIE 5 Jahre Gewerblich

max. 27°C Typ W

Passende Sockelleiste
EI 413
FO 660 foliert
2400 mm



Dimensionen
17,78 x 121,92 cm / 2,5 mm

Designböden 555 5515 Arctic Oak



max. 27°C Typ W

Passende Sockelleiste
EI 62
FO 660 foliert
2400 mm



Dimensionen
18,42 x 121,92 cm / 2,5 mm

Designböden 555 5530 White Sawn Cut



Passende Sockelleiste
EI 62
FO 660 foliert
2400 mm



Dimensionen
18,42 x 121,92 cm / 2,5 mm

Designböden 555 5531 Sandy Oak



			GARANTIE 15 Jahre Wohnbereich	GARANTIE 5 Jahre Gewerblich

max. 27°C Typ W

Passende Sockelleiste
EI 197
FO 660 foliert
2400 mm



Dimensionen
18,42 x 121,92 cm / 2,5 mm

Designböden 555 5303 / 470P Perfect Grey Oak



max. 27°C Typ W

Passende Sockelleiste
EI 62
FO 660 foliert
2400 mm



Dimensionen
22,86 x 150,00 cm / 2,5 mm
Dimensionen *Click!*
17,78 x 121,28 cm / 5,0 mm

Designböden 555 5425 / 425P African Grey Oak



Passende Sockelleiste
EI 126
FO 660 foliert
2400 mm



Dimensionen
22,86 x 121,92 cm / 2,5 mm
Dimensionen *Click!*
17,78 x 121,28 cm / 5,0 mm

Designböden 555 5513 Ivory Elm



max. 27°C Typ W

Passende Sockelleiste
WS 10
FO 660 foliert
2400 mm



Dimensionen
15,24 x 121,92 cm / 2,5 mm

Designböden 555 5518 Grey Driftwood



Passende Sockelleiste
WS 10
FO 660 foliert
2400 mm



Dimensionen
18,42 x 121,92 cm / 2,5 mm



Designböden 555
5518 Grey Driftwood

Raumwelt Nordischer Flair

Designböden 555 530I / 468P Perfect Sugar Oak



Passende Sockelleiste
AS 10
FO 660 foliert
2400 mm



Dimensionen
22,86 x 150,00 cm / 2,5 mm
Dimensionen *Click!*
17,78 x 121,28 cm / 5,0 mm

Designböden 555 5302 / 469P Perfect Sand Oak



Passende Sockelleiste
EI 531
FO 660 foliert
2400 mm



Dimensionen
22,86 x 150,00 cm / 2,5 mm
Dimensionen *Click!*
17,78 x 121,28 cm / 5,0 mm

Designböden 555 5308 Perfect Ivory Oak



Designböden 555 5304/47IP Perfect Tanned Oak



Passende Sockelleiste
WS 10
FO 660 foliert
2400 mm



Dimensionen
22,86 x 150,00 cm / 2,5 mm
Dimensionen *Click!*
17,78 x 121,28 cm / 5,0 mm

Designböden 555 5413/413P Bleached Elm



			GARANTIE 15 Jahre Wandelversicherung	GARANTIE 5 Jahre Gewerkschutz

max. 27°C Typ W

Passende Sockelleiste
WS 10
FO 660 foliert
2400 mm



Dimensionen
17,78 x 121,92 cm / 2,5 mm
Dimensionen *Click!*
17,12 x 121,27 cm / 5,0 mm

Designböden 555 5509 / 478P Spring Oak



Passende Sockelleiste
EI 184
FO 660 foliert
2400 mm



Dimensionen
18,42 x 121,92 cm / 2,5 mm
Dimensionen *Click!*
17,78 x 121,28 cm / 5,0 mm

Designböden 555 5204 Brown Cracked Oak



Passende Sockelleiste
WS 10
FO 660 foliert
2400 mm



Dimensionen
17,78 x 121,92 cm / 2,5 mm

Designböden 555 5410/410P Misty Oak



Passende Sockelleiste
EI 610
FO 660 foliert
2400 mm



Dimensionen
17,78 x 121,92 cm / 2,5 mm
Dimensionen *Click!*
17,12 x 121,27 cm / 5,0 mm

Designböden 555 5529 Rustic Grey Oak



			GARANTIE 15 Jahre Wandbereich	GARANTIE 5 Jahre Gemeinschaftsbereich

max. 27°C Typ W

Passende Sockelleiste
WS 10
FO 660 foliert
2400 mm



Dimensionen
18,42 x 121,92 cm / 2,5 mm

Designböden 555 5203 Urban Grey Oak



Passende Sockelleiste
WS 10
FO 660 foliert
2400 mm



Dimensionen
17,78 x 121,92 cm / 2,5 mm

Designböden 555 5433 Cloudy Oak



Passende Sockelleiste
EI 172
FO 660 foliert
2400 mm



Dimensionen
17,78 x 121,92 cm / 2,5 mm

Designböden 555 5434/434P Eclipse Oak



			GARANTIE 15 Jahre Wohnbereich	GARANTIE 5 Jahre Gewerblich

max. 27°C Typ W

Passende Sockelleiste
EI 172
FO 660 foliert
2400 mm



Dimensionen
17,78 x 121,92 cm / 2,5 mm
Dimensionen *Click!*
17,12 x 121,27 cm / 5,0 mm

Designböden 555 5517 Yellow Sawn Cut



Passende Sockelleiste
WS 10
FO 660 foliert
2400 mm



Dimensionen
18,42 x 121,92 cm / 2,5 mm

Designböden 555 5528 Wormy Grey Fir



Passende Sockelleiste
WS 10
FO 660 foliert
2400 mm



Dimensionen
18,42 x 121,92 cm / 2,5 mm



Designböden 555
5525 Purple Larch
Teppichböden Trend/Atlantis | Piazza 24
Tapeten Vernissage | Nr. 411
Möbelstoffe Castle | Blanket 711 406 040

Raumwelt Elegante Erscheinung



Designböden 555 5525 Purple Larch



Passende Sockelleiste
WS 10
FO 660 foliert
2400 mm



Dimensionen
18,42 x 121,92 cm / 2,5 mm

Designböden 555 5514 Hickory



max. 27°C Typ W

Passende Sockelleiste
EI 54
FO 660 foliert
2400 mm



Dimensionen
18,42 x 121,92 cm / 2,5 mm

Designböden 555 5452 Classic Fir



Passende Sockelleiste
WS 10
FO 660 foliert
2400 mm



Dimensionen
17,78 x 121,92 cm / 2,5 mm

Designböden 555 5501 Creamy Maple



Passende Sockelleiste
AH 32
FO 660 foliert
2400 mm



Dimensionen
18,42 x 121,92 cm / 2,5 mm

Designböden 555 5205 French Blond Oak



Passende Sockelleiste
WS 10
FO 660 foliert
2400 mm



Dimensionen
17,78 x 121,92 cm / 2,5 mm

Designböden 555 5532 Natural Fir



max. 27°C Typ W

Passende Sockelleiste
EI 22
FO 660 foliert
2400 mm



Dimensionen
18,42 x 121,92 cm / 2,5 mm

Designböden 555 5511 Wormy Light Oak



max. 27°C	Typ W			

Passende Sockelleiste
PI 07
FO 660 foliert
2400 mm



Dimensionen
18,42 x 121,92 cm / 2,5 mm

Designböden 555 5412/412P Cozy Oak



max. 27°C Typ W

Passende Sockelleiste
EI 12
FO 660 foliert
2400 mm



Dimensionen
17,78 x 121,92 cm / 2,5 mm
Dimensionen *Click!*
17,12 x 121,27 cm / 5,0 mm



Designböden 555
5412 / 412P Click! Cozy Oak

Raumwelt Natürlicher Charakter

Designböden 555 5407 / 407P Blond Pine



			GARANTIE 15 Jahre Wohnbereich	GARANTIE 5 Jahre Gewerblich
max. 27°C	Typ W			

Passende Sockelleiste
PI 07
FO 660 foliert
2400 mm



Dimensionen
17,78 x 121,92 cm / 2,5 mm
Dimensionen *Click!*
17,12 x 121,27 cm / 5,0 mm



Designböden 555
5208 / 476P *Click!* Incredible Classic Oak
Teppichböden Format | Ornamenta 33
Tapeten Carat | Nr. 17609

Raumwelt Natürlicher Charakter

Designböden 555 5208 / 476P Incredible Classic Oak



Passende Sockelleiste
EI 684
FO 660 foliert
2400 mm



Dimensionen
18,50 x 150,50 cm / 2,5 mm
Dimensionen *Click!*
17,78 x 121,28 cm / 5,0 mm

Designböden 555 5306 / 473P Perfect Brown Oak



Designböden 555 5524 Honey Oak



max. 27°C Typ W

Passende Sockelleiste
EI 12
FO 660 foliert
2400 mm



Dimensionen
18,42 x 121,92 cm / 2,5 mm

Nordischer NFlair

330
2835 / 835P
White
Limed Oak

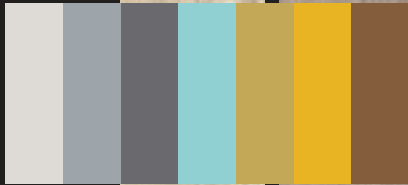

555
5424 / 424P Imperial Oak

create your room

Mit Raumwelt Produkten, Möbeln, Accessoires
und Farben *natürlich schöne Räume* gestalten.



555 XXL
9629 / 629
Brown Mixed Oak



Designböden 555
5424 / 424P Click! Imperial Oak
Teppichfliesen Quattro | Straightforward II 8017
Objektstoffe Creativo | Eigendesign 33438 C015
Tapeten Glory | Nr. 17025

Raumwelt Nordischer Flair

Designböden 555 5424 / 424P Imperial Oak













Passende Sockelleiste
EI 24
FO 660 foliert
2400 mm



Dimensionen
22,86 x 121,92 cm / 2,5 mm
Dimensionen *Click!*
17,78 x 121,28 cm / 5,0 mm

Designböden 555 5408 / 408P Wild Maple



max. 27°C Typ W

Passende Sockelleiste
EI 42
FO 660 foliert
2400 mm



Dimensionen
17,78 x 121,92 cm / 2,5 mm
Dimensionen *Click!*
17,12 x 121,27 cm / 5,0 mm













Designböden 555
5414 Wild Oak

Raumwelt Natürlicher Charakter

Designböden 555 5414/414P Wild Oak



max. 27°C Typ W

Passende Sockelleiste
EI 614
FO 660 foliert
2400 mm



Dimensionen
17,78 x 121,92 cm / 2,5 mm
Dimensionen *Click!*
17,12 x 121,27 cm / 5,0 mm

Designböden 555 5454 Brown Nuttree



Passende Sockelleiste
 NU 81
 FO 660 foliert
 2400 mm



Dimensionen
 17,78 x 121,92 cm / 2,5 mm

Designböden 555 5504 Cottage Oak



Passende Sockelleiste
EI 550
FO 660 foliert
2400 mm



Dimensionen
22,86 x 121,92 cm / 2,5 mm

Designböden 555 5209 / 477P Incredible Dark Oak



Passende Sockelleiste
 NU 15
 FO 660 foliert
 2400 mm



Dimensionen
 18,50 x 150,50 cm / 2,5 mm
 Dimensionen *Click!*
 17,78 x 121,28 cm / 5,0 mm

Designböden 555 5443 Black Scream



max. 27°C	Typ W			

Passende Sockelleiste
WS 10
FO 660 foliert
2400 mm



Dimensionen
45,72 x 91,44 cm / 2,5 mm

Designböden 555 5453 Country Blond Pine



Designböden 555 5455 Light Tetris Wood

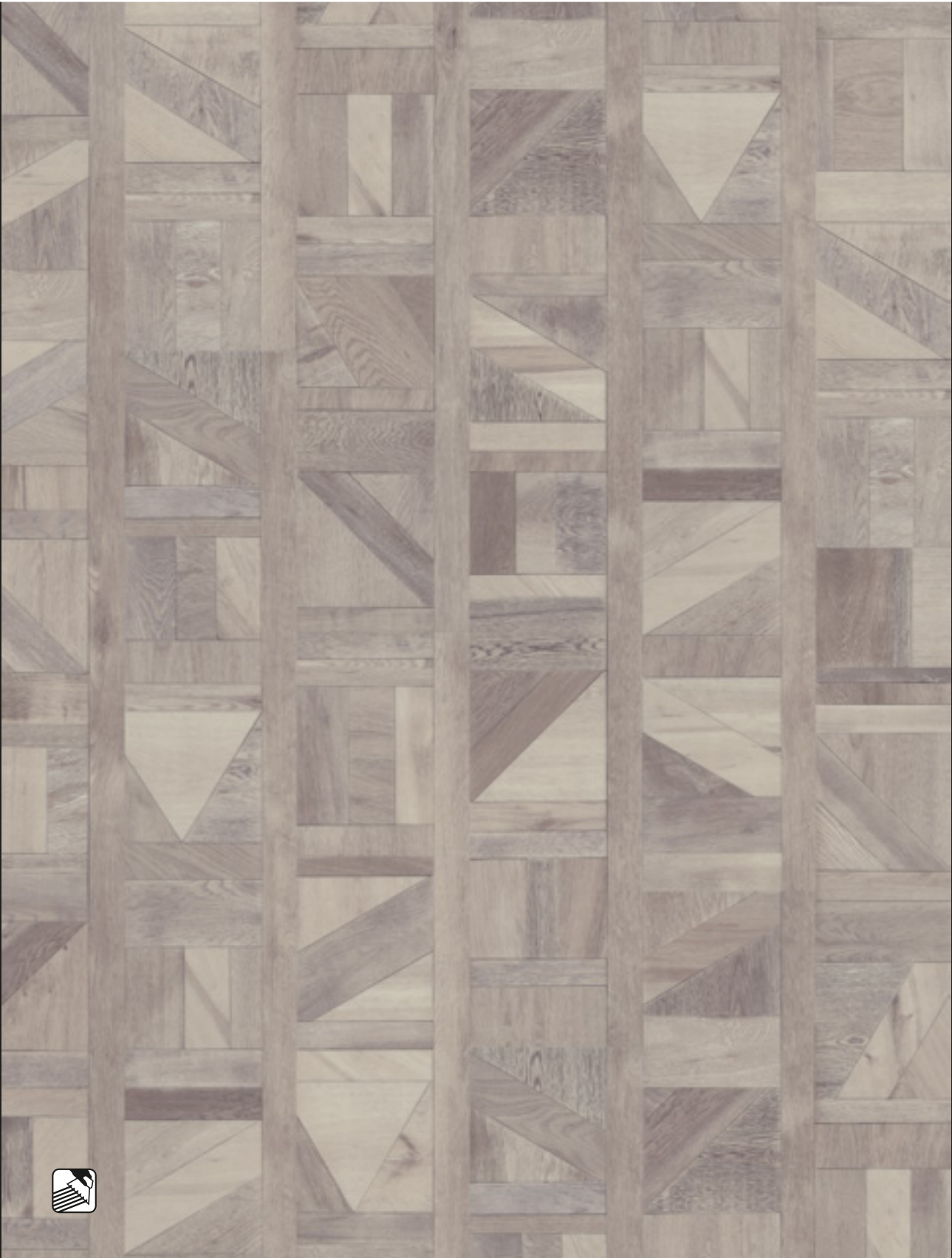

max. 27°C Typ W

Passende Sockelleiste

EI 539

FO 660 foliert

2400 mm



Dimensionen

22,86 x 151,70 cm / 2,5 mm



Designböden 555
5457 Brown Tetris Wood
Teppichböden Hotel Konzept | Savoy 25
Möbelstoffe Castle 711 | Blanket 711 406 074
Tapeten Vernissage | Nr. 420100

Raumwelt Nordischer Flair

Designböden 555 5457 Brown Tetris Wood



			GARANTIE 15 Jahre Wahlbereich	GARANTIE 5 Jahre Gewerblich

max. 27°C Typ W

Passende Sockelleiste
EI 36
FO 660 foliert
2400 mm



Dimensionen
22,86 x 151,70 cm / 2,5 mm

Designböden 555 5456 Dark Tetris Wood







Passende Sockelleiste
EI 663
FO 660 foliert
2400 mm











Dimensionen
22,86 x 151,70 cm / 2,5 mm

Designböden 555 5458 Mixed Ornament



max. 27°C Typ W

Passende Sockelleiste
 WS 10
 FO 660 foliert
 2400 mm



Dimensionen
 45,72 x 91,44 cm / 2,5 mm

Lebendige Vielfalt

555 XXL
9627 / 627
Caramel Oak

create your room

Mit Raumwelt Produkten, Möbeln, Accessoires und Farben *natürlich schöne Räume* gestalten.



330
2809 Grey
Mixed Oak

555
5458 Mixed
Ornament















Designböden 555
5458 Mixed Ornament
Objektstoffe Cambio | Istres 707 012 053 |
707 011 062 | 707 012 085 Sitzauflage
Tapeten Grandeco | Nr. MO6001

Raumwelt Lebendige Vielfalt

Designböden 555 5459 / 459P Old Patch blue



				
				
max. 27°C		Typ W		

Passende Sockelleiste
WS 10
FO 660 foliert
2400 mm



Dimensionen
45,72 x 91,44 cm / 2,5 mm
Dimensionen *Click!*
45,08 x 90,80 cm / 5,0 mm

Designböden 555 5460 Old Patch beige



			GARANTIE 15 Jahre Wandbereich	GARANTIE 5 Jahre Gangbereich
max. 27°C	Typ W			

Passende Sockelleiste
WS 10
FO 660 foliert
2400 mm



Dimensionen
45,72 x 91,44 cm / 2,5 mm

Designböden 555 5461 Old Patch grey



Designböden 555 5202 Brown Driftwood















Passende Sockelleiste
EI 134
FO 660 foliert
2400 mm



Dimensionen
17,78 x 121,92 cm / 2,5 mm

Designböden 555 5201 Country Grey Oak



max. 27°C Typ W









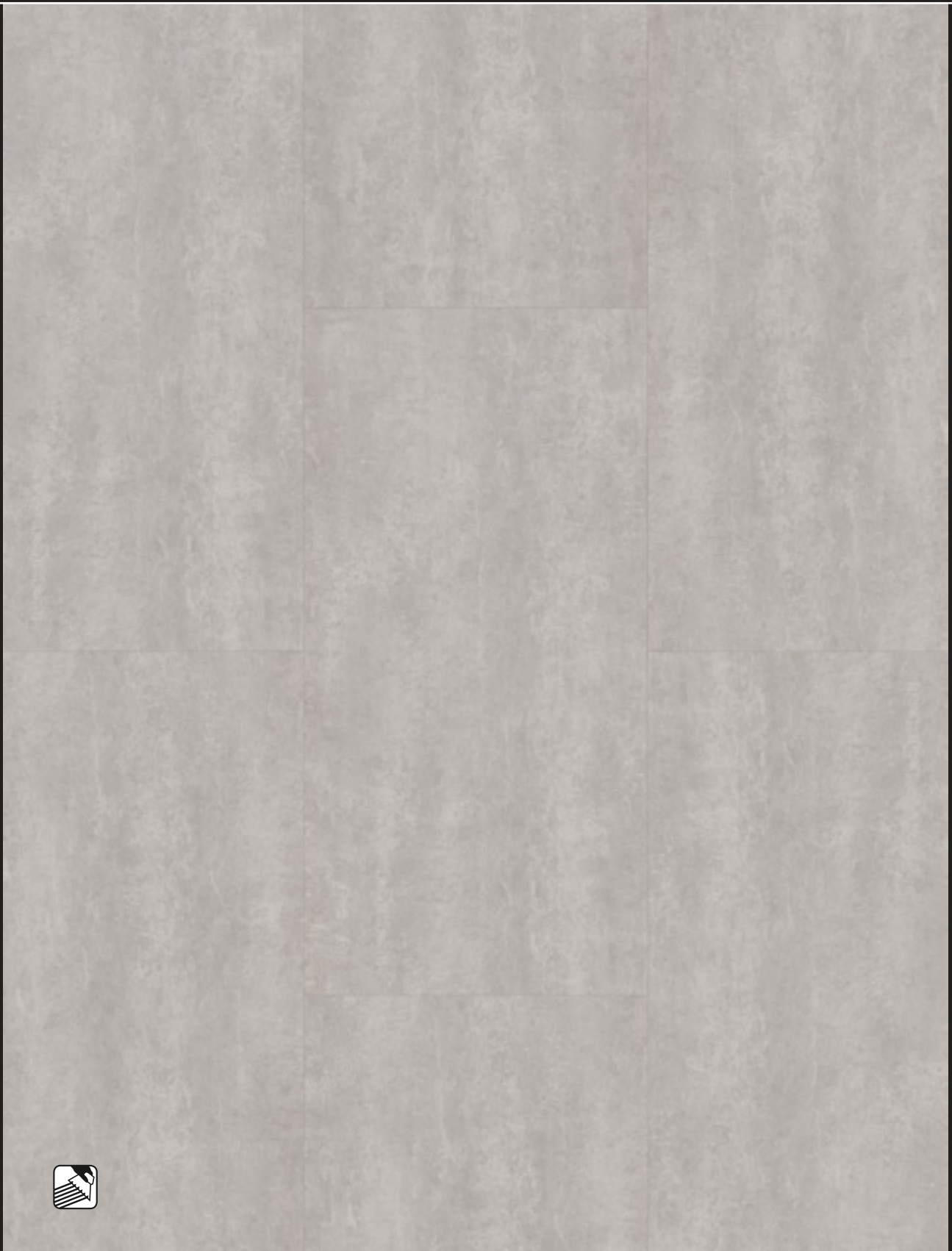

Passende Sockelleiste
EI 899
FO 660 foliert
2400 mm



Dimensionen
17,78 x 121,92 cm / 2,5 mm

Designböden 555 5210 Crystal Stone



max. 27°C Typ W

Passende Sockelleiste
WS 10
FO 660 foliert
2400 mm



Dimensionen
45,72 x 91,44 cm / 2,5 mm



9626 Royal Oak



AUSGESPROCHEN
R O B U S T

GROSSZÜGIGES
A M B I E N T E



9625 Western Oak

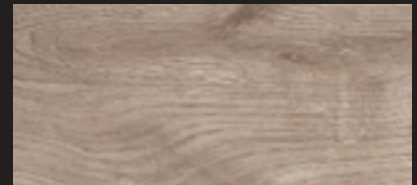

9629 Brown mixed Oak

G E S U N D E S
R A U M K L I M A

F Ü H L B A R E
S T R U K T U R



9627 Caramel Oak



Designböden **555 XXL**

Design flooring / Sols design / Pavimenti vinilici modulari LVT

Vorteile

Advantages / Avantages / Vantaggi



Bewährte Klebevariante

- **geringe Aufbauhöhe**
*low construction height /
montage sur une faible épaisseur /
altezza di costruzione ridotta*
- **einfacher Plankenaustausch**
*easy to replace boards /
remplacement aisé d'un panneau /
facile sostituzione delle tavole*
- **für Feuchträume geeignet**
*suitable for most environments /
compatible milieu humide /
adatto per ambienti umidi*



Clickversion mit Pro Connect-Technologie

- **schnelle & saubere Verlegung**
*fast and clean installation /
pose rapide et propre /
installazione rapida e pulita*
- **starke Verbindungen**
*stable connections /
connexions stables /
connessioni resistenti*
- **Maß- und Dimensionsstabilität**
*dimensional stability /
stabilité dimensionnelle /
stabilità delle dimensioni e delle misure*

Designböden 555 XXL 9623 / 623 Beach Oak



Passende Sockelleiste
EI 197
FO 660 foliert
2400 mm

Dimensionen
23,0 x 180,0 cm / 2,5 mm
22,3 x 179,2 cm / 5 mm Click!

Designböden 555 XXL 9624 / 624 Celtic Oak



max. 27°C Typ W

Passende Sockelleiste
EI 159
FO 660 foliert
2400 mm

Dimensionen
23,0 x 180,0 cm / 2,5 mm
22,3 x 179,2 cm / 5 mm Click!

Designböden 555 XXL 9625 / 625 Western Oak



max. 27°C Typ W

Passende Sockelleiste

EI 05

FO 660 foliert

2400 mm

Dimensionen

23,0 x 180,0 cm / 2,5 mm

22,3 x 179,2 cm / 5 mm Click!

Designböden 555 XXL 9626 / 626 Royal Oak













Passende Sockelleiste
 EI 12
 FO 660 foliert
 2400 mm

Dimensionen
 23,0 x 180,0 cm / 2,5 mm
 22,3 x 179,2 cm / 5 mm Click!

Designböden 555 XXL 9627 / 627 Caramel Oak



Passende Sockelleiste

EI 12

FO 660 foliert

2400 mm

Dimensionen

23,0 x 180,0 cm / 2,5 mm

22,3 x 179,2 cm / 5 mm Click!

Designböden 555 XXL 9628 / 628 Viking Oak



max. 27°C Typ W

Passende Sockelleiste
EI 802
FO 660 foliert
2400 mm

Dimensionen
23,0 x 180,0 cm / 2,5 mm
22,3 x 179,2 cm / 5 mm Click!

Designböden 555 XXL 9629 / 629 Brown Mixed Oak



Passende Sockelleiste
EI 127
FO 660 foliert
2400 mm

Dimensionen
23,0 x 180,0 cm / 2,5 mm
22,3 x 179,2 cm / 5 mm Click!

Designböden 555 XXL 9630 / 630 Fog Oak



Passende Sockelleiste
EI 127
FO 660 foliert
2400 mm

Dimensionen
23,0 x 180,0 cm / 2,5 mm
22,3 x 179,2 cm / 5 mm Click!



Designböden 555 XXL
9630 / 630 Click! Fog Oak
Wohnstoffe | Breeze 506 302
Tapeten Glory | Nr. 17023

Raumwelt Weltoffene Akzente





2834 Grey Pine

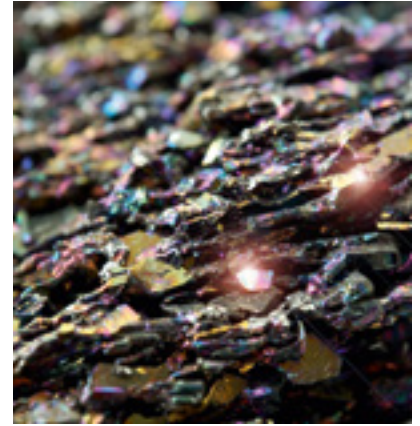

SPANNENDE
OPTIKEN

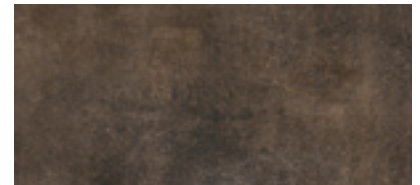

2858 Dark Moonstone

VIELFÄLTIGE
DEKORE

LANGLEBIG &
ROBUST



2861 Washed Brown Pine



Designböden **330**

Design flooring / Sols design / Pavimenti vinilici modulari LVT

Vorteile

Advantages / Avantages / Vantaggi



Bewährte Klebevariante

- **geringe Aufbauhöhe**
*low construction height /
montage sur une faible épaisseur /
altezza di costruzione ridotta*
- **einfacher Plankenaustausch**
*easy to replace boards /
remplacement aisé d'un panneau /
facile sostituzione delle tavole*
- **für Feuchträume geeignet**
*suitable for most environments /
compatible milieu humide /
adatto per ambienti umidi*

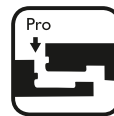

Clickversion mit Pro Connect-Technologie

- **schnelle & saubere Verlegung**
*fast and clean installation /
pose rapide et propre /
installazione rapida e pulita*
- **starke Verbindungen**
*stable connections /
connexions stables /
connessioni resistenti*
- **Maß- und Dimensionsstabilität**
*dimensional stability /
stabilité dimensionnelle /
stabilità delle dimensioni e delle misure*

Designböden 330 2827 Sky Oak



Passende Sockelleiste

PI 32

FO 660 foliert

2400 mm

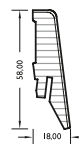











Dimensionen

15,24 x 121,92 cm / 2,0 mm

Designböden 330 2835/835P White Limed Oak







GARANTIE
15 Jahre
in Wohnbereich

max. 27°C Typ W

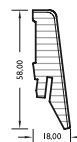
Passende Sockelleiste
 EI II
 FO 660 foliert
 2400 mm



Dimensionen
 15,24 x 121,92 cm / 2,0 mm
 Dimensionen *Click!*
 17,81 x 124,46 cm / 4,5 mm



Designböden 330
2835 / 835P Click! White Limed Oak
Teppichböden Trend/Atlantis | Metro 21
Wohnstoffe | Dotty 618 021 070
Tapeten Linea | Nr. 16828

Raumwelt Nordischer Flair



Designböden 330 2848 Stormy Oak



Passende Sockelleiste

EI 539

FO 660 foliert

2400 mm

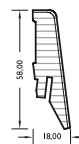

Dimensionen

18,42 x 121,92 cm / 2,0 mm

Designböden 330 2849 / 849P Scandinavian Pine



max. 27°C Typ W

Passende Sockelleiste
WS 10
FO 660 foliert
2400 mm

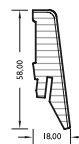

Dimensionen
18,42 x 121,92 cm / 2,0 mm
Dimensionen *Click!*
17,81 x 124,46 cm / 4,5 mm

Designböden 330 2850 Iceland Ash



Passende Sockelleiste
WS 10
FO 660 foliert
2400 mm

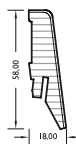

Dimensionen
18,42 x 121,92 cm / 2,0 mm

Designböden 330 285I / 85IP Milky Maple



Passende Sockelleiste

EI 04
FO 660 foliert
2400 mm

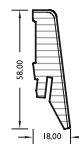

Dimensionen

18,42 x 121,92 cm / 2,0 mm

Dimensionen *Click!*

17,81 x 124,46 cm / 4,5 mm

Designböden 330 2852 / 852P Summer Maple



Passende Sockelleiste
AH 313
FO 660 foliert
2400 mm

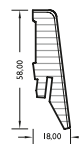

Dimensionen
18,42 x 121,92 cm / 2,0 mm
Dimensionen *Click!*
17,81 x 124,46 cm / 4,5 mm

Designböden 330 2853/853P Worn Ash

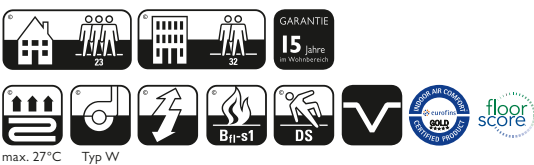

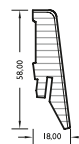

Passende Sockelleiste
E1 62
FO 660 foliert
2400 mm









Dimensionen
18,42 x 121,92 cm / 2,0 mm
Dimensionen *Click!*
17,81 x 124,46 cm / 4,5 mm

Designböden 330 2823 / 823P Vanilla Oak







GARANTIE
15 Jahre
in Wohnbereich

max. 27°C Typ W

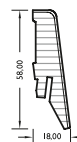
Passende Sockelleiste
 EI 159
 FO 660 foliert
 2400 mm



Dimensionen
 18,42 x 121,92 cm / 2,0 mm
 Dimensionen *Click!*
 17,81 x 124,46 cm / 4,5 mm

Designböden 330 2824/824P Wormy Light Oak

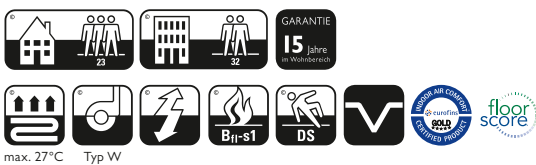

Passende Sockelleiste

PI 07

FO 660 foliert

2400 mm

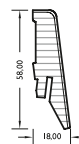

Dimensionen

15,24 x 121,92 cm / 2,0 mm

Dimensionen *Click!*

17,81 x 124,46 cm / 4,5 mm

Designböden 330 2825 Wild Pine



Passende Sockelleiste

EI 77

FO 660 foliert

2400 mm

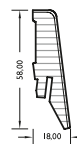

Dimensionen

18,42 x 121,92 cm / 2,0 mm

Designböden 330 2819 Creamy Maple



Passende Sockelleiste

EI 837

FO 660 foliert

2400 mm

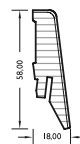

Dimensionen

11,43 x 121,92 cm / 2,0 mm

Designböden 330 2817 Light Oak



Passende Sockelleiste

EI 10
FO 660 foliert
2400 mm

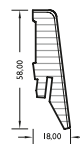

Dimensionen

11,43 x 121,92 cm / 2,0 mm

Designböden 330 2818 Blond Beech



Passende Sockelleiste

EI 10

FO 660 foliert

2400 mm

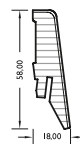

Dimensionen

11,43 x 121,92 cm / 2,0 mm

max. 27°C Typ W

Designböden 330 2821 Flamy Aspen



Passende Sockelleiste
RE 176
FO 660 foliert
2400 mm

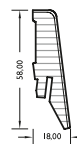

Dimensionen
11,43 x 121,92 cm / 2,0 mm

Designböden 330 2816 Wild Oak



Passende Sockelleiste

EI 42

FO 660 foliert

2400 mm

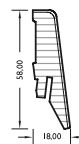

Dimensionen

11,43 x 121,92 cm / 2,0 mm

max. 27°C Typ W

Designböden 330 2854/854P Fresh Oak

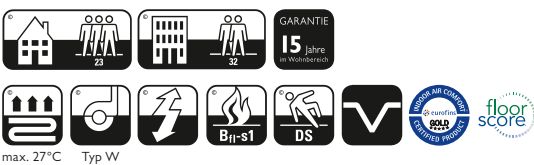

Passende Sockelleiste
EI 680
FO 660 foliert
2400 mm

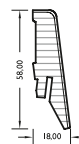

Dimensionen
18,42 x 121,92 cm / 2,0 mm
Dimensionen *Click!*
17,81 x 124,46 cm / 4,5 mm

Designböden 330 2855/855P Golden Pine



max. 27°C Typ W

Passende Sockelleiste
WS 10
FO 660 foliert
2400 mm

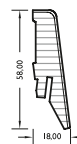

Dimensionen
18,42 x 121,92 cm / 2,0 mm
Dimensionen *Click!*
17,81 x 124,46 cm / 4,5 mm

Designböden 330 2856 Vintage Timber



Passende Sockelleiste

EI 22

FO 660 foliert

2400 mm

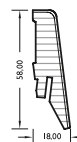

Dimensionen

18,42 x 121,92 cm / 2,0 mm

Designböden 330 2812/812P Pure Oak

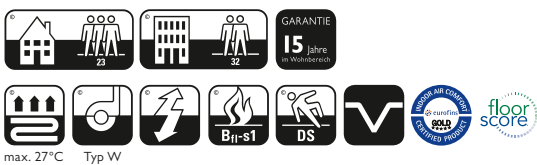

Passende Sockelleiste

EI 12
FO 660 foliert
2400 mm

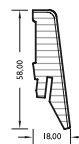

Dimensionen

18,42 x 121,92 cm / 2,0 mm

Dimensionen *Click!*

17,81 x 124,46 cm / 4,5 mm

Natürlicher Charakter

←
555 XXL
9626 / 626
Royal Oak

create your room

Mit Raumwelt Produkten, Möbeln, Accessoires
und Farben **natürlich schöne Räume** gestalten.



↗
555
5208 / 476 P
Incredible
Classic Oak



↖
330
2812 / 812P
Pure Oak





Designböden 330
2812 Pure Oak
Teppichböden Wool | Malta 28
Wohnstoffe | Pintura 218 022 020
Tapeten Glory | Nr. 17000

Raumwelt Natürlicher Charakter

Designböden 330 2833 / 833P Waxed Oak





GARANTIE
15 Jahre
in Wohnbereich









max. 27°C Typ W

Passende Sockelleiste
 EI 802
 FO 660 foliert
 2400 mm

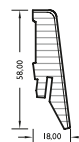

Dimensionen
 15,24 x 121,92 cm / 2,0 mm
 Dimensionen *Click!*
 17,81 x 124,46 cm / 4,5 mm

Designböden 330 2811 Airy Oak



Passende Sockelleiste

EI 811

FO 660 foliert

2400 mm

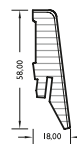

Dimensionen

18,42 x 121,92 cm / 2,0 mm

max. 27°C Typ W





Designböden 330
2834 / 834P Click! Grey Pine
Teppichböden Trend/Atlantis | Piazza 24
Wohnstoffe | Cella 217 178
Tapeten La Veneziana | Nr. 16946

Raumwelt Weltoffene Akzente

Designböden 330 2834/834P Grey Pine



Passende Sockelleiste

EI 05
FO 660 foliert
2400 mm

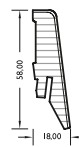

Dimensionen

18,42 x 121,92 cm / 2,0 mm

Dimensionen *Click!*

17,81 x 124,46 cm / 4,5 mm

Designböden 330 2808 Ivory Elm



max. 27°C Typ W

Passende Sockelleiste
WS 10
FO 660 foliert
2400 mm

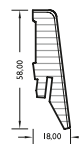

Dimensionen
15,24 x 121,92 cm / 2,0 mm

Elegante Erscheinung

555
5455 Light
Tetris Wood



330
2840 / 840P Old Grey Oak

create your room

Mit Raumwelt Produkten, Möbeln, Accessoires
und Farben **natürlich schöne Räume** gestalten.



555 XXL
9625 / 625
Western Oak



Designböden 330
2840 Old Grey Oak
Teppichböden Trend/Atlantis | Metro 83
Wohnstoffe | Dorset 218 018 082
Tapeten Sky | Nr. 16700 | Nr. 16703

Raumwelt Elegante Erscheinung

Designböden 330 2840/840P Old Grey Oak



Passende Sockelleiste

EI 127

FO 660 foliert

2400 mm

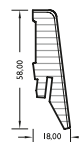

Dimensionen

18,42 x 121,92 cm / 2,0 mm

Dimensionen *Click!*

17,81 x 124,46 cm / 4,5 mm

Designböden 330 2830 Old Spruce



max. 27°C



Typ W



Bfl-s1



DS



V



floor score

Passende Sockelleiste

EI 127

FO 660 foliert

2400 mm

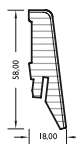

Dimensionen

15,24 x 121,92 cm / 2,0 mm

Designböden 330 2809 Grey Mixed Oak



Passende Sockelleiste
WS 10
FO 660 foliert
2400 mm

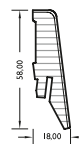

Dimensionen
15,24 x 121,92 cm / 2,0 mm

Designböden 330 2832 / 832P Highland Oak





GARANTIE
15 Jahre
in Wohnbereich









max. 27°C Typ W

Passende Sockelleiste
 WS 10
 FO 660 foliert
 2400 mm

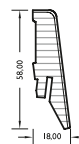

Dimensionen
 18,42 x 121,92 cm / 2,0 mm
 Dimensionen *Click!*
 17,81 x 124,46 cm / 4,5 mm

Weltoffene Akzente

330
2814 Antique Oak

555 XXL
9630 / 630
Fog Oak

create your room

Mit Raumwelt Produkten, Möbeln, Accessoires und Farben *natürlich schöne Räume* gestalten.



555
5444 Grey
Screed

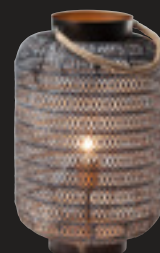











Designböden 330
2814 / 814P *Click!* Antique Oak
Teppichböden Trend | Rigoletto 84
Wohnstoffe | Ginestra 218 028 064
Tapeten Pearl | Nr. 15823

Raumwelt Weltoffene Akzente

Designböden 330 2814/814P Antique Oak







GARANTIE
15 Jahre
in Wohnbereich

max. 27°C Typ W B_{fl}-s1 DS floor score

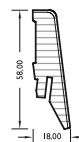
Passende Sockelleiste
 EI 14
 FO 660 foliert
 2400 mm



Dimensionen
 15,24 x 121,92 cm / 2,0 mm
 Dimensionen *Click!*
 17,81 x 124,46 cm / 4,5 mm

Designböden 330 2837 Bourbon Spruce



max. 27°C Typ W

Passende Sockelleiste

EI 170

FO 660 foliert

2400 mm

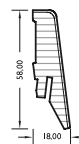



Dimensionen







15,24 x 121,92 cm / 2,0 mm

Designböden 330 2857/857P Classic Nuttree

 MULTICOLOR



max. 27°C Typ W

Passende Sockelleiste
 NU 15
 FO 660 foliert
 2400 mm

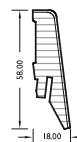

Dimensionen
 18,42 x 121,92 cm / 2,0 mm
 Dimensionen *Click!*
 17,81 x 124,46 cm / 4,5 mm

Designböden 330 2839 / 839P Barrel Pine





GARANTIE
15 Jahre
in Wohnbereich









max. 27°C Typ W

Passende Sockelleiste
 EI 610
 FO 660 foliert
 2400 mm

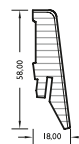

Dimensionen
 18,42 x 121,92 cm / 2,0 mm
 Dimensionen *Click!*
 17,81 x 124,46 cm / 4,5 mm

Designböden 330 2842 Hickory



Passende Sockelleiste

EI 54

FO 660 foliert

2400 mm

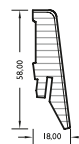











Dimensionen

15,24 x 121,92 cm / 2,0 mm

Designböden 330 2858 Dark Moonstone







GARANTIE
15 Jahre
in Wohnbereich

max. 27°C Typ W

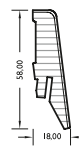
Passende Sockelleiste
 WS 10
 FO 660 foliert
 2400 mm



Dimensionen
 18,42 x 121,92 cm / 2,0 mm

Designböden 330 2859 Light Moonstone



Passende Sockelleiste
WS 10
FO 660 foliert
2400 mm

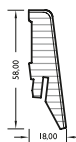



Dimensionen
18,42 x 121,92 cm / 2,0 mm







Designböden 330
2860/860P Dark Limed Oak



 **MULTICOLOR**



max. 27°C Typ W

Passende Sockelleiste
WS 10
FO 660 foliert
2400 mm



Dimensionen
18,42 x 121,92 cm / 2,0 mm
Dimensionen *Click!*
17,81 x 124,46 cm / 4,5 mm

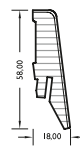

Designböden 330
2861 Washed Brown Pine
Teppichböden Trend/Atlantis | Fortuna 780
Sonnenschutz | Plisado P2258
Tapeten Glory | Nr. 17085

Raumwelt Lebendige Vielfalt



Designböden 330 2861 Washed Brown Pine

 MULTICOLOR



Passende Sockelleiste

WS 10

FO 660 foliert

2400 mm

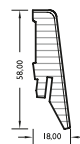

Dimensionen

18,42 x 121,92 cm / 2,0 mm

Designböden 330 2862 Treated Maple

 MULTICOLOR



Passende Sockelleiste

WS 10

FO 660 foliert

2400 mm

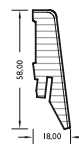

Dimensionen

18,42 x 121,92 cm / 2,0 mm









max. 27°C Typ W

Designböden 330
2863 / 863P Brown Limed Oak



 MULTICOLOR



max. 27°C Typ W

Passende Sockelleiste
WS 10
FO 660 foliert
2400 mm

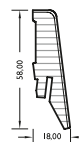

Dimensionen
18,42 x 121,92 cm / 2,0 mm
Dimensionen *Click!*
17,81 x 124,46 cm / 4,5 mm

Designböden 330 2844 Travertine

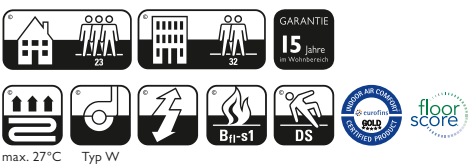

max. 27°C Typ W

Passende Sockelleiste
WS 10
FO 660 foliert
2400 mm

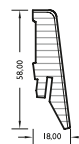

Dimensionen
30,48 x 60,96 cm / 2,0 mm

Designböden 330 2847/847P Metallic Slate

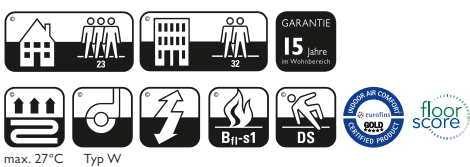

Passende Sockelleiste
WS 10
FO 660 foliert
2400 mm

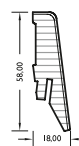

Dimensionen
30,48 x 60,96 cm / 2,0 mm
Dimensionen *Click!*
30,31 x 60,72 cm cm / 4,5 mm

Designböden 330 2864 Dark Silver Stone

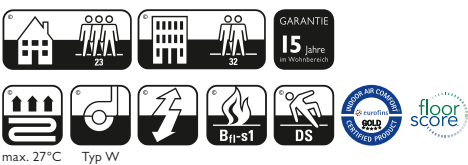

Passende Sockelleiste
WS 10
FO 660 foliert
2400 mm

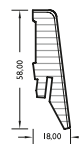

Dimensionen
45,72 x 91,44 cm / 2,0 mm

Designböden 330 2865 / 865P Bright Concrete

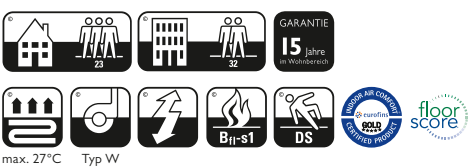

Passende Sockelleiste
WS 10
FO 660 foliert
2400 mm

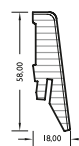

Dimensionen
45,72 x 91,44 cm / 2,0 mm
Dimensionen *Click!*
30,31 x 60,72 cm / 4,5 mm

Designböden 330 2845 / 845P Dark Concrete

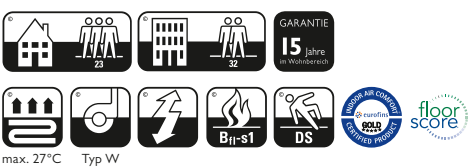

Passende Sockelleiste
WS 10
FO 660 foliert
2400 mm

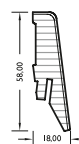

Dimensionen
45,72 x 45,72 cm cm / 2,0 mm
Dimensionen *Click!*
30,31 x 60,72 cm cm / 4,5 mm

Designböden 330 2866/866P Grey Washed Stone

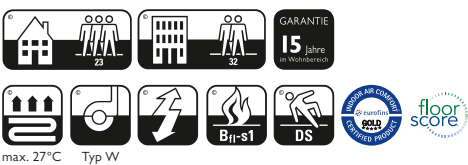

Passende Sockelleiste
WS 10
FO 660 foliert
2400 mm

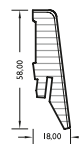

Dimensionen
45,72 x 91,44 cm / 2,0 mm
Dimensionen *Click!*
30,31 x 60,72 cm / 4,5 mm

Designböden 330 2867 / 867P Light Washed Stone

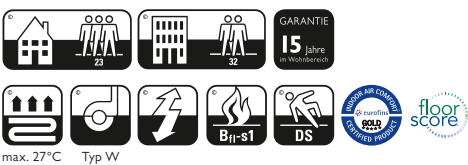

Passende Sockelleiste
WS 10
FO 660 foliert
2400 mm

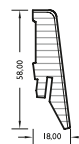

Dimensionen
45,72 x 91,44 cm / 2,0 mm
Dimensionen *Click!*
30,31 x 60,72 cm / 4,5 mm

Designböden 330

2868 Rustic Brown Stone



GARANTIE
15 Jahre
in Wohnbereich



Passende Sockelleiste
WS 10
FO 660 foliert
2400 mm

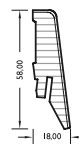

Dimensionen
45,72 x 91,44 cm / 2,0 mm

Designböden 330 2869 Rusty Stone

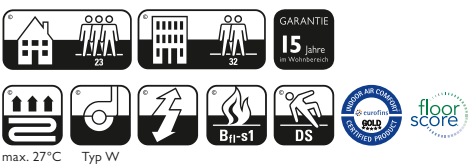

max. 27°C Typ W

Passende Sockelleiste
WS 10
FO 660 foliert
2400 mm

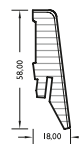

Dimensionen
45,72 x 91,44 cm / 2,0 mm

Designböden 330 2806 Grey Slate

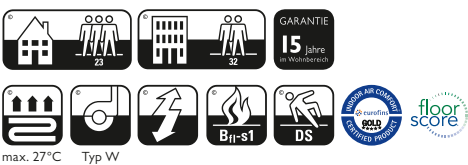

Passende Sockelleiste
WS 10
FO 660 foliert
2400 mm

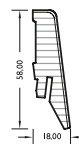

Dimensionen
30,48 x 60,96 cm / 2,0 mm

Akzentstreifen

Feature strips / Filets / Fughe a strisce



Silver 6 mm

Der Einsatz von Designelementen unterstützt das Ambiente entscheidend. Akzentstreifen sind in unterschiedlichen Farben erhältlich.

The use of design elements has a major impact on the ambiance. Accent strips are available in different colours.

L'utilisation d'éléments design conforte l'ambiance de façon déterminante. Les baguettes décoratives sont disponibles en différentes couleurs.

L'utilizzo di elementi di design è il decoro essenziale dell'ambiente. Le strisce accent sono disponibili in colori diversi.

Stärke *Thickness / Calibre / Spessore*
1,8 mm / 2,0 mm / 2,3 mm

White 3 x 915 mm / 6 x 915 mm

Black 3 x 915 mm / 6 x 915 mm

Light Beige 3 x 915 mm / 6 x 915 mm

Dark Grey 3 x 915 mm / 6 x 915 mm

Brown 3 x 915 mm / 6 x 915 mm

Silver 3 x 915 mm / 6 x 915 mm

Zertifikate

Certificates / Certificats / Certificati



Alle JOKA/INKU Designböden entsprechen allen grundlegenden europäischen Sicherheits- & Gesundheitsrichtlinien.

All JOKA / INKU Design floors meet all essential European Health and Safety Directives.

La gamme des revêtements de sol JOKA / INKU Sols Design répond à toutes les exigences européennes en matière de santé et de sécurité.

Tutti i pavimenti design JOKA / INKU sono conformi alle direttive europee sulla salute e la sicurezza.



Das Indoor Air Comfort Gold Zertifikat garantiert niedrigste Emissionen bei einem Produkt. Es kombiniert alle europäischen Verordnungen zu VOC sowie alle relevanten freiwilligen Umweltzeichen.

The Indoor Air Comfort Gold Certificate guarantees lowest emissions for a product. It combines all European regulations on VOC as well as all relevant voluntary environmental labels.

Le certificat Indoor Air Comfort Gold garantit les émissions les plus faibles possibles pour ce produit. Il englobe toutes les réglementations européennes sur les COV (composés organiques volatils) ainsi que les écolabels appropriés (sur une base volontaire).

Il certificato Indoor Air Comfort Gold garantisce le più basse emissioni di un prodotto. Combina tutte le normative europee in materia di VOC e tutte le etichette ecologiche rilevanti volontarie.



Designböden sind phthalatfrei!

Das Bewusstsein für die gesellschaftliche, soziale und ökologische Verantwortung aller Unternehmensaktivitäten ist einer unserer Unternehmensgrundsätze. Aus diesem Grund entschied sich JOKA / INKU bewusst, bei seinen Designböden, auf alternative, phthalatfreie Weichmacher umzusteigen.

Design floors are phthalate-free!

An awareness of the societal, social and environmental responsibility of all corporate activities is one of our corporate principles. This is the reason why JOKA / INKU has deliberately decided to switch to alternative, phthalate-free plasticisers in its design floors.

Les Sols Design sont sans phthalate !!

La prise de conscience de la responsabilité sociétale, sociale et environnementale dans toutes nos activités est l'un des fondements de notre société. Pour cette raison, JOKA / INKU a décidé en connaissance de cause de passer à des plastifiants de substitution sans phthalate pour ses Sols Design.

I pavimenti design sono privi di ftalato.

La consapevolezza della responsabilità sociale e ambientale di tutte le attività a livello di società è uno dei nostri principi. Per questo motivo JOKA / INKU ha deciso consapevolmente di passare a piani di progettazione alternativi privi di ftalati.



In Frankreich gültige Information über die Diffusion von flüchtigen Stoffen (A+ sehr schwache Emission bis C sehr starke Emission).

Information valid in France on the diffusion of volatiles (A+ very weak emission up to C very strong emission).

In Pour la France des informations valides sont nécessaires sur la diffusion de substances volatiles allant de A+ très faible émission à -C très forte émission .

In Francia, le informazioni valide sulla diffusione di sostanze volatili (A+ emissione molto debole -C emissione molto forte).



Das Floorscore®-Zertifikat bestätigt, dass alle JOKA/INKU Designböden 330 / 555 die Raumluftqualität nicht beeinträchtigen.

The Floorscore® certificate confirms that all JOKA/INKU design floors 330 / 555 have good indoor air quality.

Le certificat Floorscore® confirme que tous les revêtements de sol JOKA/INKU Design 330 / 555 offrent une bonne qualité d'air intérieur.

Il certificato Floorscore® certifica una buona qualità dell'aria interna per tutti i pavimenti design JOKA/INKU 330 / 555.

REACH

Die REACH-Verordnung (Registration, Evaluation, Authorisation and Restriction of Chemicals) verpflichtet Hersteller/Importeure über Substanzen der „Kandidatenliste der Europäischen Chemikalienagentur“ zu informieren, deren Anteil eine Konzentration von 0,1 Massenprozent übersteigt.

The REACH regulation (Registration, Evaluation, Authorisation and Restriction of Chemicals) requires manufacturers/importers to provide recipients with information on substances on the „Candidate list of the European Chemicals agency“, the portion of which exceeds a concentration of 0.1 weight by weight.

La réglementation REACH (Enregistrement, Evaluation, Autorisation and Restriction des produits chimiques) oblige les fabricants/importateurs à l'information pour ce qui concerne les substances figurant sur la liste de l'Agence européenne des Produits Chimiques dont une partie excède une concentration de 0,1 de sa masse .

Il regolamento REACH (registrazione, valutazione, autorizzazione e restrizione delle sostanze chimiche) obbliga i fabbricanti / gli importatori di sostanze a informare la "lista dei candidati dell'Agenzia europea delle sostanze chimiche", la cui quota supera una concentrazione di 0,1% della massa.



Qualität ohne Kompromisse – und das garantiert bis zu 15 Jahren im Wohnbereich und 5 Jahren im Objektbereich (555). Garantie gemäß den Garantiebedingungen.

Quality with no compromise – and guaranteed up to 15 years in your living areas and 5 years in contract areas. Guarantee as per the terms of warranty.

Qualité irréprochable – et garantie 15 ans dans les lieux de vie et 5 ans dans commercial moyennement. Voir les conditions de garantie.

Qualità senza compromessi, questo garantisce la zona giorno fino a 15 anni e l'ambiente pubblico 5 anni. Garanzia alle condizioni di garanzia.



Nutzungsklassen

23: Wohnbereich mit starker Nutzung

Living areas exposed to heavy use

Les lieux de vie très sollicités

La zona giorno fino con utilizzo intenso



31/32/33: Objektbereich mit mittlerer / normaler / starker Nutzung

Contract areas exposed to general / normal / heavy use



Espace commercial moyennement / normalement / très sollicité



Ambiente pubblico con utilizzo medio / normale / intenso



max. 27°C

Geeignet für Warmwasserfußbodenheizung

Suitable for hot water underfloor heating

Convient tout à fait au chauffage hydraulique par le sol

Adatto per il riscaldamento a pavimento con acqua calda



Antistatische Eigenschaften

Antistatic qualities

Antistatique

Caratteristiche antistatiche



Brandklasse Bfl-s1: schwer entflammbar

Fire class Bfl-s1: flame-retardant

Classification Bfl-s1: difficilement inflammable

Classe di infiammabilità Bfl-s1: difficilmente infiammabile



Rutschhemmung

Anti-slip properties

Effet antidérapant

Resistenza allo scivolamento

Sockelleisten weiß

Skirting boards white / Plinthes blanches / Battiscopa bianco



FO 631



FO 842

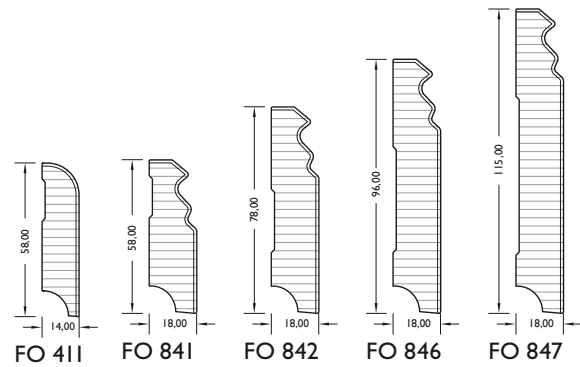
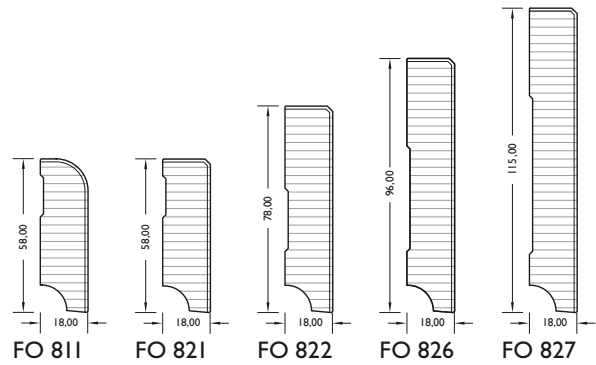
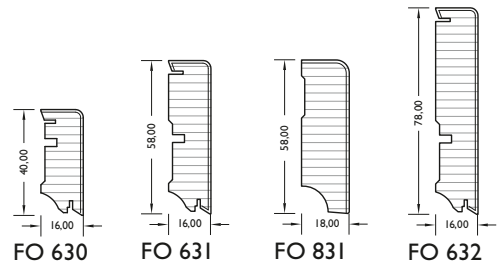

Passende Sockelleisten

Matching skirting boards / Plinthes assorties / Battiscopa coordinato



FO 660

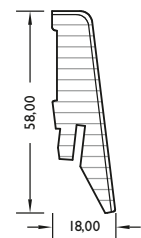

Clip 660

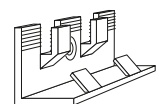

Eckenlösungen für Sockelleisten

Corner solutions for skirting boards / Solutions d'angles pour plinthes / Soluzioni ad angolo per battiscopa



Verlegemöglichkeiten

Fitting options / Différentes méthodes de pose / Opzioni di installazione

Grenzenlose Gestaltungsmöglichkeiten

Durch die Kombination verschiedener Oberflächen oder Farben in den Grundformaten lassen sich unterschiedliche Designstile realisieren. Verlegerichtungen können kombiniert, Räume strukturiert und Zonen gestaltet werden.

Unlimited design options

Different design styles can be created by combining different surfaces or colours in the basic shapes. Fitting directions can be combined, rooms structured and zones designed.

Conception et pose aux possibilités infinies

Dans les formats de base, la combinaison de différentes surfaces ou couleurs, permet de réaliser toute sorte de styles et designs. Le sens de la pose peut quand il est mixte, délimiter des espaces et aménager des zones.

Possibilità di design illimitate

Grazie alla combinazione di superfici o colori diversi nei formati di base, è possibile realizzare diversi stili di design. È possibile combinare le direzioni di posa, strutturare le stanze e progettare le zone.

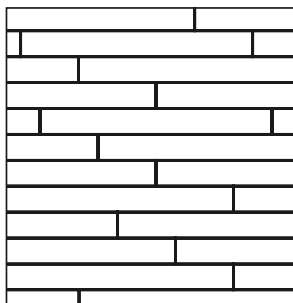

unregelmäßig / irregular / irrégulière / irregolare

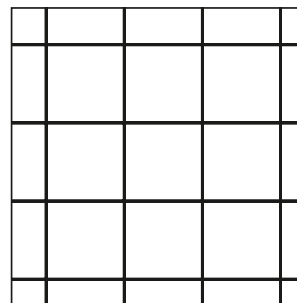

auf Fuge / on joint / sur joint / a interstizio

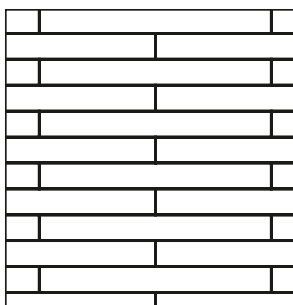

regelmäßig, halber Versatz / regular, half offset / égulière, semi-décallee / regolare, falzato a metà

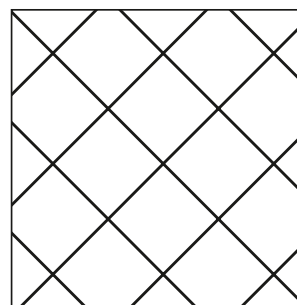

diagonal / diagonal / diagonale / diagonale

Pflege

Care / Entretien / Manutenzione









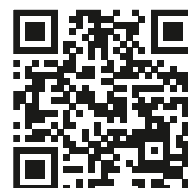

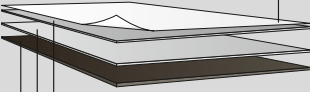
Entscheidend für die Werterhaltung von Designböden ist die richtige Pflege. Die Pflegeanleitungen finden sie auf: www.joka-servicebox.de









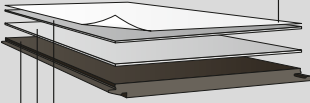

The right care is crucial when it comes to maintaining the value of design floors. For maintenance instructions, see: www.joka-servicebox.de









Seul un entretien spécifique permet la préservation des qualités du revêtement design. Vous trouverez les instructions d'entretien sur notre site: www.joka-servicebox.de

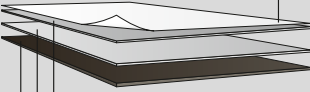







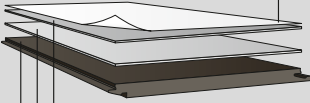

Decisiva per mantenere il valore della pavimenti design è la manutenzione giusta. Le istruzioni manutenzione sono disponibili all'indirizzo: www.joka-servicebox.de











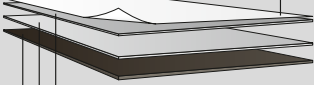









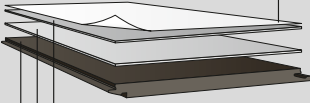

Technische Daten <i>Technical data</i> <i>Caractéristiques techniques</i> <i>Dati tecnici</i>	Eigenschaften <i>Characteristics</i> <i>Caractéristiques</i> <i>Caratteristiche</i>	Norm <i>Standards</i> <i>Norme</i> <i>Norma</i>	Einheit <i>Unit</i> <i>Unité</i> <i>Unità</i>	555 <i>2,5 mm</i>	
<p>Designböden <i>Design flooring /</i> <i>Sols design /</i> <i>Pavimenti vinilici</i> <i>modulari LVT</i></p> <p>555 Klebevariante</p> <p>Transparente Nutzschicht inkl. PU-Vergütung <i>Transparent wear layer</i> <i>incl. PU treatment</i> <i>Couche d'usure transparente</i> <i>traitement PU incl.</i> <i>Strato di usura trasparente</i> <i>incl. trattamento PU</i></p>  <p>Fotofilm (Holz/Stein) <i>Printed film layer (wood/stone)</i> <i>Film décoratif (bois/pierre)</i> <i>Strato dec. (legno/pietra)</i></p> <p>Stabilisierungsschicht <i>Stabilisation layer</i> <i>Couche de stabilisation</i> <i>Strato di stabilizzazione</i></p> <p>Trägermaterial PVC <i>Support layer PVC</i> <i>Couche de fond PVC</i> <i>Materiale di supporto PVC</i></p> <p> Designböden sind phthalatfrei! <i>Design floors are phthalate-free!</i> <i>Les Sols Design sont sans phtalate !!</i> <i>I pavimenti design sono privi di ftalato.</i></p> <p> Indoor Air Comfort Gold Zertifikat <i>Indoor Air Comfort Gold Certificate</i> <i>certificat Indoor Air Comfort Gold</i> <i>certificato Indoor Air Comfort Gold</i></p> <p>REACH</p> <p> EN 14041:2004</p> <p></p> <p><small>* abhängig von Konzentration und Einwirkzeit / depending on concentration and time of exposure / dépend de la concentration et de la durée de contact / secondo concentrazione e durata</small></p>	Belagsart <i>Type of floorcovering</i> <i>Type de revêtement</i> <i>Tipo di rivestimento</i>	DIN EN ISO 10582		PVC, heterogen <i>PVC, heterogeneous</i> <i>PVC, hétérogène</i> <i>PVC, eterogeneo</i>	
	Oberflächenvergütung <i>Surface treatment</i> <i>Traitement de surface</i> <i>Trattamento superficie</i>				
	Flächengewicht <i>Total weight</i> <i>Poids total</i> <i>Peso totale</i>	ISO 23997 EN 430	g/m ²		ca. 4.310
	Klassifizierung <i>Classification</i> <i>Classements</i> <i>Classificazione</i>	DIN EN ISO 10874			23, 33, 42
	Gesamtdicke <i>Overall thickness</i> <i>Épaisseur totale</i> <i>Spessore totale</i>	DIN EN ISO 24346	mm		2,5
	Nutzschichtdicke <i>Wear layer thickness</i> <i>Épaisseur couche d'usure</i> <i>Spessore strato di usura</i>	DIN EN ISO 24340	mm		0,55
	Gefaste Kanten <i>Bevelled edges</i> <i>Lames chanfreinées</i> <i>Angoli smussati</i>				ja yes oui si
	Resteindruck <i>Residual indentation</i> <i>Poinçonnement résiduel</i> <i>Impronta residua</i>	DIN EN ISO 24343-1	mm		≤ 0,1
	Farbbeständigkeit <i>Colour fastness</i> <i>Tenue à la lumière</i> <i>Tenuta dei colori</i>	ISO 105-B02 Methode A (DIN 53388/9)	Stufe level degré livello		≥ 6 bei künstl. Licht ≥ 6 artificial light ≥ 6 lumière artificielle ≥ 6 alla luce artificiate
	Brandverhalten <i>Behaviour to fire</i> <i>Classement feu</i> <i>Comportamento al fuoco</i>	EN 13501-1			B _{fl} -s1
	Rutschhemmung <i>Slip resistance</i> <i>Résistance au glissement</i> <i>Resistenza allo scivolamento</i>	DIN 51130 EN 13893			R10 DS
	Trittschallverbesserung <i>Impact sound reduction</i> <i>Bruits d'impact</i> <i>Riduzione impatto sonoro</i>	ISO 10140-3 ISO 140-8	dB		ca. 2
	Wärmedurchlasswst. <i>Thermal conductivity</i> <i>Conductibilité thermique</i> <i>Resistenza termica</i>	DIN 52612 EN 12667	m ² k/w		0,02
	Elektrost. Verhalten <i>Electrostatic properties</i> <i>Charge électrostatique</i> <i>Comportamento elettrost.</i>	EN 1815 	kV		< 2
	Ableitwiderstand <i>Vertical resistance</i> <i>Résistance électrique</i> <i>Resistenza elettrica</i>	EN 1081	Ohm		ca. 10 ⁹
	Chemikalienbest. <i>Chemical resistance</i> <i>Substances chimiques</i> <i>Resistenza chimica</i>	EN 423			beständig* resistant* résistant* resistente*
Bindemittelgehalt <i>Binder content</i> <i>Contenu en liant</i> <i>Contenuto del raccoglitore</i>	DIN EN ISO 10582			Typ I ≥ 80 %	
Stuhlrolleneignung <i>Castor chair</i> <i>Sièges à roulettes</i> <i>Idoneità sedia a rotelle</i>	ISO 4918 			ja, Typ W (EN 12529) yes, type W (EN 12529) oui, typ W (EN 12529) si, tipo W (EN 12529)	
Fußbodenheizung <i>Underfloor heating</i> <i>Chauffage par le sol</i> <i>Riscaldamento a pavimento</i>	EN 1264 			geeignet, max. 29 °C suitable, max. 29 °C approprié, max. 29 °C adatto, max. 29 °C	

Technische Daten <i>Technical data</i> <i>Caractéristiques techniques</i> <i>Dati tecnici</i>	Eigenschaften <i>Characteristics</i> <i>Caractéristiques</i> <i>Caratteristiche</i>	Norm <i>Standards</i> <i>Norme</i> <i>Norma</i>	Einheit <i>Unit</i> <i>Unité</i> <i>Unità</i>	555 Click! 5,0 mm	
<p>Designböden <i>Design flooring /</i> <i>Sols design /</i> <i>Pavimenti vinilici</i> <i>modulari LVT</i></p> <p>555 Clickversion</p> <p>Transparente Nutzschicht inkl. PU-Vergütung <i>Transparent wear layer</i> incl. PU treatment <i>Couche d'usure transparente</i> traitement PU incl. <i>Strato di usura trasparente</i> incl. trattamento PU</p>  <p>Fotofilm (Holz/Stein) <i>Printed film layer (wood/stone)</i> <i>Film décoratif (bois/pierre)</i> <i>Strato dec. (legno/pietra)</i></p> <p>Stabilisierungsschicht <i>Stabilisation layer</i> <i>Couche de stabilisation</i> <i>Strato di stabilizzazione</i></p> <p>Trägermaterial PVC <i>Support layer PVC</i> <i>Couche de fond PVC</i> <i>Materiale di supporto PVC</i></p> <p> Designböden sind phthalatfrei! <i>Design floors are phthalate-free!</i> <i>Les Sols Design sont sans phtalate !!</i> <i>I pavimenti design sono privi di ftalato.</i></p> <p> Indoor Air Comfort Gold Zertifikat <i>Indoor Air Comfort Gold Certificate</i> <i>certificat Indoor Air Comfort Gold</i> <i>certificato Indoor Air Comfort Gold</i></p> <p>REACH</p> <p> EN 14041:2004</p> <p></p> <p><small>* abhängig von Konzentration und Einwirkzeit / depending on concentration and time of exposure / dépend de la concentration et de la durée de contact / secondo concentrazione e durata</small></p>	Belagsart <i>Type of floorcovering</i> <i>Type de revêtement</i> <i>Tipo di rivestimento</i>	DIN EN ISO 10582		PVC, heterogen <i>PVC, heterogeneous</i> <i>PVC, hétérogène</i> <i>PVC, eterogeneo</i>	
	Oberflächenvergütung <i>Surface treatment</i> <i>Traitement de surface</i> <i>Trattamento superficie</i>				
	Flächengewicht <i>Total weight</i> <i>Poids total</i> <i>Peso totale</i>	ISO 23997 EN 430	g/m ²		ca. 9.530
	Klassifizierung <i>Classification</i> <i>Classements</i> <i>Classificazione</i>	DIN EN ISO 10874			23, 33, 42
	Gesamtdicke <i>Overall thickness</i> <i>Épaisseur totale</i> <i>Spessore totale</i>	DIN EN ISO 24346	mm		5,0
	Nutzschichtdicke <i>Wear layer thickness</i> <i>Épaisseur couche d'usure</i> <i>Spessore strato di usura</i>	DIN EN ISO 24340	mm		0,55
	Gefaste Kanten <i>Bevelled edges</i> <i>Lames chanfreinées</i> <i>Angoli smussati</i>				ja yes oui si
	Resteindruck <i>Residual indentation</i> <i>Poinçonnement résiduel</i> <i>Impronta residua</i>	DIN EN ISO 24343-1	mm		≤ 0,15
	Farbbeständigkeit <i>Colour fastness</i> <i>Tenue à la lumière</i> <i>Tenuta dei colori</i>	ISO 105-B02 Methode A (DIN 53388/9)	Stufe level degré livello		≥ 6 bei künstl. Licht ≥ 6 artificial light ≥ 6 lumière artificielle ≥ 6 alla luce artificiate
	Brandverhalten <i>Behaviour to fire</i> <i>Classement feu</i> <i>Comportamento al fuoco</i>	EN 13501-1			B _{fl} -s1
	Rutschhemmung <i>Slip resistance</i> <i>Résistance au glissement</i> <i>Resistenza allo scivolamento</i>	DIN 51130 EN 13893			R10 DS
	Trittschallverbesserung <i>Impact sound reduction</i> <i>Bruits d'impact</i> <i>Riduzione impatto sonoro</i>	ISO 10140-3 ISO 140-8	dB		ca. 9
	Wärmedurchlasswst. <i>Thermal conductivity</i> <i>Conductibilité thermique</i> <i>Resistenza termica</i>	DIN 52612 EN 12667	m ² k/w		0,02
	Elektrost. Verhalten <i>Electrostatic properties</i> <i>Charge électrostatique</i> <i>Comportamento elettrost.</i>	EN 1815 	kV		< 2
	Ableitwiderstand <i>Vertical resistance</i> <i>Résistance électrique</i> <i>Resistenza elettrica</i>	EN 1081	Ohm		ca. 10 ⁹
	Chemikalienbest. <i>Chemical resistance</i> <i>Substances chimiques</i> <i>Resistenza chimica</i>	EN 423			beständig* resistant* résistant* resistente*
	Bindemittelgehalt <i>Binder content</i> <i>Contenu en liant</i> <i>Contenuto del raccoglitore</i>	DIN EN ISO 10582			Typ I ≥ 80 %
	Stuhlrolleneignung <i>Castor chair</i> <i>Sièges à roulettes</i> <i>Idoneità sedia a rotelle</i>	ISO 4918 			ja, Typ W (EN 12529) yes, type W (EN 12529) oui, typ W (EN 12529) si, tipo W (EN 12529)
Fußbodenheizung <i>Underfloor heating</i> <i>Chauffage par le sol</i> <i>Riscaldamento a pavimento</i>	EN 1264 			geeignet, max. 29 °C suitable, max. 29 °C approprié, max. 29 °C adatto, max. 29 °C	

Technische Daten Technical data Caractéristiques techniques Dati tecnici	Eigenschaften Characteristics Caractéristiques Caratteristiche	Norm Standards Norme Norma	Einheit Unit Unité Unità	555 XXL 2,5 mm	
<p>Designböden <i>Design flooring / Sols design / Pavimenti vinilici modulari LVT</i></p> <p>555 XXL Klebevariante</p> <p>Transparente Nutzschicht inkl. PU-Vergütung <i>Transparent wear layer incl. PU treatment Couche d'usure transparente traitement PU incl. Strato di usura trasparente incl. trattamento PU</i></p>  <p>Fotofilm (Holz/Stein) <i>Printed film layer (wood/stone) Film décoratif (bois/pierre) Strato dec. (legno/pietra)</i></p> <p>Stabilisierungsschicht <i>Stabilisation layer Couche de stabilisation Strato di stabilizzazione</i></p> <p>Trägermaterial PVC <i>Support layer PVC Couche de fond PVC Materiale di supporto PVC</i></p> <p>Phthalatfrei! NEW Technologie</p> <p>Designböden sind phthalatfrei! <i>Design floors are phthalate-free! Les Sols Design sont sans phthalate !! I pavimenti design sono privi di ftalato.</i></p> <p>Indoor Air Comfort Gold Zertifikat <i>Indoor Air Comfort Gold Certificate certificat Indoor Air Comfort Gold certificato Indoor Air Comfort Gold</i></p> <p>REACH</p>  <p>EN 14041:2004</p>  <p><small>* abhängig von Konzentration und Einwirkzeit / depending on concentration and time of exposure / dépend de la concentration et de la durée de contact / secondo concentrazione e durata</small></p>	Belagsart <i>Type of floorcovering Type de revêtement Tipo di rivestimento</i>	ISO 10581		PVC, heterogen <i>PVC, heterogeneous PVC, hétérogène PVC, eterogeneo</i>	
	Oberflächenvergütung <i>Surface treatment Traitement de surface Trattamento superficie</i>				
	Flächengewicht <i>Total weight Poids total Peso totale</i>	ISO 23997	g/m ²	ca. 4.300	
	Klassifizierung <i>Classification Classements Classificazione</i>	DIN EN ISO 10874		23, 33, 42	
	Gesamtdicke <i>Overall thickness Epaisseur totale Spessore totale</i>	ISO 24346	mm	2,5	
	Nutzschichtdicke <i>Wear layer thickness Epaisseur couche d'usure Spessore strato di usura</i>	ISO 24340	mm	0,55	
	Gefaste Kanten <i>Bevelled edges Lames chanfreinées Angoli smussati</i>			ja yes oui sì	
	Resteindruck <i>Residual indentation Poinçonnement résiduel Impronta residua</i>	ISO 24343-1 ISO 24343	mm	≤ 0,1	
	Farbbeständigkeit <i>Colour fastness Tenue à la lumière Tenuta dei colori</i>	ISO 105-B02	Stufe level degré livello	≥ 6 bei künstl. Licht ≥ 6 artificial light ≥ 6 lumière artificielle ≥ 6 alla luce artificiate	
	Brandverhalten <i>Behaviour to fire Classement feu Comportamento al fuoco</i>	EN 13501-1		B _{fl} -s1	
	Rutschhemmung <i>Slip resistance Résistance au glissement Resistenza allo scivolamento</i>	DIN 51130 EN 13893		R10 DS	
	Trittschallverbesserung <i>Impact sound reduction Bruits d'impact Riduzione impatto sonoro</i>	ISO 10140-3 ISO 10140	dB	ca. 3	
	Wärmedurchlasswst. <i>Thermal conductivity Conductibilité thermique Resistenza termica</i>	EN 12667	m ² k/w	0,02	
	Elektrost. Verhalten <i>Electrostatic properties Charge électrostatique Comportamento elettrost.</i>	EN 1815		kV	< 2
	Ableitwiderstand <i>Vertical resistance Résistance électrique Resistenza elettrica</i>	EN 1081	Ohm	ca. 10 ⁹	
	Chemikalienbest. <i>Chemical resistance Substances chimiques Resistenza chimica</i>	ISO 26987		beständig* resistant* résistant* resistente*	
Bindemittelgehalt <i>Binder content Contenu en liant Contenuto del raccoglitore</i>	ISO 10582		Typ I ≥ 80 %		
Stuhlrolleneignung <i>Castor chair Sièges à roulettes Idoneità sedia a rotelle</i>	ISO 4918		ja, Typ W (EN 12529) yes, type W (EN 12529) oui, typ W (EN 12529) sì, tipo W (EN 12529)		
Fußbodenheizung <i>Underfloor heating Chauffage par le sol Riscaldamento a pavimento</i>	EN 1264-2		geeignet, max. 27 °C suitable, max. 27 °C approprié, max. 27 °C adatto, max. 27 °C		

Technische Daten Technical data Caractéristiques techniques Dati tecnici	Eigenschaften Characteristics Caractéristiques Caratteristiche	Norm Standards Norme Norma	Einheit Unit Unité Unità	555 XXL Click! 5,0 mm	
<p>Designböden <i>Design flooring / Sols design / Pavimenti vinilici modulari LVT</i></p> <p>555 XXL Clickversion</p> <p>Transparente Nutzschicht inkl. PU-Vergütung <i>Transparent wear layer incl. PU treatment Couche d'usure transparente traitement PU incl. Strato di usura trasparente incl. trattamento PU</i></p>  <p>Fotofilm (Holz/Stein) <i>Printed film layer (wood/stone) Film décoratif (bois/pierre) Strato dec. (legno/pietra)</i></p> <p>Kalibrierende Mittelschicht <i>Calendaring middle layer Couche moyenne calibrée Calibrato medio strato</i></p> <p>Extrudiertes PVC-Trägermaterial <i>inkl. Fiberglas (Solid Board) Extruded Support layer PVC incl. fiber glass / Extrudée couche de fond PVC incl. laine de verre (Solid Board) / Materiale di supporto in PVC estruso incl. la vetroresina (Solid Board)</i></p> <p> Designböden sind phthalatfrei! <i>Design floors are phthalate-free! Les Sols Design sont sans phthalate !! I pavimenti design sono privi di ftalato.</i></p> <p> Indoor Air Comfort Gold Zertifikat <i>Indoor Air Comfort Gold Certificate certificat Indoor Air Comfort Gold certificato Indoor Air Comfort Gold</i></p> <p>REACH</p> <p> EN 14041:2004</p> <p></p> <p><small>* abhängig von Konzentration und Einwirkzeit / depending on concentration and time of exposure / dépend de la concentration et de la durée de contact / secondo concentrazione e durata</small></p>	Belagsart <i>Type of floorcovering Type de revêtement Tipo di rivestimento</i>	ISO 10581		PVC, heterogen <i>PVC, heterogeneous PVC, hétérogène PVC, eterogeneo</i>	
	Oberflächenvergütung <i>Surface treatment Traitement de surface Trattamento superficie</i>				
	Flächengewicht <i>Total weight Poids total Peso totale</i>	ISO 23997	g/m ²	ca. 9.760	
	Klassifizierung <i>Classification Classements Classificazione</i>	DIN EN ISO 10874		23, 33, 42	
	Gesamtdicke <i>Overall thickness Epaisseur totale Spessore totale</i>	ISO 24346	mm	5,0	
	Nutzschichtdicke <i>Wear layer thickness Epaisseur couche d'usure Spessore strato di usura</i>	ISO 24340	mm	0,55	
	Gefaste Kanten <i>Bevelled edges Lames chanfreinées Angoli smussati</i>			ja yes oui sì	
	Resteindruck <i>Residual indentation Poinçonnement résiduel Impronta residua</i>	ISO 24343-1 ISO 24343	mm	≤ 0,1	
	Farbbeständigkeit <i>Colour fastness Tenue à la lumière Tenuta dei colori</i>	ISO 105-B02	Stufe level degré livello	≥ 6 bei künstl. Licht ≥ 6 artificial light ≥ 6 lumière artificielle ≥ 6 alla luce artificiate	
	Brandverhalten <i>Behaviour to fire Classement feu Comportamento al fuoco</i>	EN 13501-1		B _{fl-s1}	
	Rutschhemmung <i>Slip resistance Résistance au glissement Resistenza allo scivolamento</i>	DIN 51130 EN 13893		R10 DS	
	Trittschallverbesserung <i>Impact sound reduction Bruits d'impact Riduzione impatto sonoro</i>	ISO 10140-3 ISO 10140	dB	ca. 7	
	Wärmedurchlasswst. <i>Thermal conductivity Conductibilité thermique Resistenza termica</i>	EN 12667	m ² k/w	0,02	
	Elektrost. Verhalten <i>Electrostatic properties Charge électrostatique Comportamento elettrost.</i>	EN 1815		kV	< 2
	Ableitwiderstand <i>Vertical resistance Résistance électrique Resistenza elettrica</i>	EN 1081		Ohm	ca. 10 ⁹
	Chemikalienbest. <i>Chemical resistance Substances chimiques Resistenza chimica</i>	ISO 26987			beständig* resistant* résistant* resistente*
Bindemittelgehalt <i>Binder content Contenu en liant Contenuto del raccoglitore</i>	ISO 10582			Typ I ≥ 80 %	
Stuhlrolleneignung <i>Castor chair Sièges à roulettes Idoneità sedia a rotelle</i>	ISO 4918			ja, Typ W (EN 12529) yes, type W (EN 12529) oui, typ W (EN 12529) sì, tipo W (EN 12529)	
Fußbodenheizung <i>Underfloor heating Chauffage par le sol Riscaldamento a pavimento</i>	EN 1264-2			geeignet, max. 27 °C suitable, max. 27 °C approprié, max. 27 °C adatto, max. 27 °C	

Technische Daten Technical data Caractéristiques techniques Dati tecnici	Eigenschaften Characteristics Caractéristiques Caratteristiche	Norm Standards Norme Norma	Einheit Unit Unité Unità	330 2,0 mm	
<p>Designböden <i>Design flooring / Sols design / Pavimenti vinilici modulari LVT</i></p> <p>330 Klebevariante</p> <p>Transparente Nutzschicht inkl. PU-Vergütung <i>Transparent wear layer incl. PU treatment Couche d'usure transparente traitement PU incl. Strato di usura trasparente incl. trattamento PU</i></p>  <p>Fotofilm (Holz/Stein) <i>Printed film layer (wood/stone) Film décoratif (bois/pierre) Strato dec. (legno/pietra)</i></p> <p>Stabilisierungsschicht <i>Stabilisation layer Couche de stabilisation Strato di stabilizzazione</i></p> <p>Trägermaterial PVC <i>Support layer PVC Couche de fond PVC Materiale di supporto PVC</i></p> <p> Designböden sind phthalatfrei! <i>Design floors are phthalate-free! Les Sols Design sont sans phtalate !! I pavimenti design sono privi di ftalato.</i></p> <p> Indoor Air Comfort Gold Zertifikat <i>Indoor Air Comfort Gold Certificate certificat Indoor Air Comfort Gold certificato Indoor Air Comfort Gold</i></p> <p>REACH</p> <p> EN 14041:2004</p> <p></p> <p><small>* abhängig von Konzentration und Einwirkzeit / depending on concentration and time of exposure / dépend de la concentration et de la durée de contact / secondo concentrazione e durata</small></p>	Belagsart <i>Type of floorcovering Type de revêtement Tipo di rivestimento</i>	EN 649		PVC, heterogen <i>PVC, heterogeneous PVC, hétérogène PVC, eterogeneo</i>	
	Oberflächenvergütung <i>Surface treatment Traitement de surface Trattamento superficie</i>				
	Flächengewicht <i>Total weight Poids total Peso totale</i>	ISO 23997	g/m ²	ca. 3.500	
	Klassifizierung <i>Classification Classements Classificazione</i>	EN 685		23, 32	
	Gesamtdicke <i>Overall thickness Epaisseur totale Spessore totale</i>	EN 428	mm	2,0	
	Nutzschichtdicke <i>Wear layer thickness Epaisseur couche d'usure Spessore strato di usura</i>	EN 429	mm	0,40	
	Gefaste Kanten <i>Bevelled edges Lames chanfreinées Angoli smussati</i>				Microfase (Holzdekore) <i>Micro fiber (wood decors) Micro fibre (décors de bois) Microfibra (decori in legno)</i>
	Resteindruck <i>Residual indentation Poinçonnement résiduel Impronta residua</i>	EN 433	mm	≤ 0,1	
	Farbbeständigkeit <i>Colour fastness Tenue à la lumière Tenuta dei colori</i>	ISO 105-B02 Methode A (DIN 53388/9)	Stufe <i>level degré livello</i>	≥ 6 bei künstl. Licht <i>≥ 6 artificial light ≥ 6 lumière artificielle ≥ 6 alla luce artificiate</i>	
	Brandverhalten <i>Behaviour to fire Classement feu Comportamento al fuoco</i>	EN 13501-1		B _{fl} -s1	
	Rutschhemmung <i>Slip resistance Résistance au glissement Resistenza allo scivolamento</i>	DIN 51130 EN 13893		R10 DS	
	Trittschallverbesserung <i>Impact sound reduction Bruits d'impact Riduzione impatto sonoro</i>	ISO 10140-3	dB	ca. 1	
	Wärmedurchlasswst. <i>Thermal conductivity Conductibilité thermique Resistenza termica</i>	DIN 52612 EN 12667	m ² k/w	0,09	
	Elektrost. Verhalten <i>Electrostatic properties Charge électrostatique Comportamento elettrost.</i>	EN 1815		kV	< 2
	Ableitwiderstand <i>Vertical resistance Résistance électrique Resistenza elettrica</i>	EN 1081		Ohm	ca. 10 ¹¹
	Chemikalienbest. <i>Chemical resistance Substances chimiques Resistenza chimica</i>	EN 423			beständig* <i>resistant* résistant* resistente*</i>
Verschleißgruppe <i>Abrasion group Résistance à l'usure Gruppo usura</i>	EN 649			T	
Stuhlrolleneignung <i>Castor chair Sièges à roulettes Idoneità sedia a rotelle</i>	EN 425			ja, Typ W (EN 12529) <i>yes, type W (EN 12529) oui, typ W (EN 12529) sì, tipo W (EN 12529)</i>	
Fußbodenheizung <i>Underfloor heating Chauffage par le sol Riscaldamento a pavimento</i>	EN 1264			geeignet, max. 27 °C <i>suitable, max. 27 °C approprié, max. 27 °C adatto, max. 27 °C</i>	

Technische Daten <i>Technical data</i> <i>Caractéristiques techniques</i> <i>Dati tecnici</i>	Eigenschaften <i>Characteristics</i> <i>Caractéristiques</i> <i>Caratteristiche</i>	Norm <i>Standards</i> <i>Norme</i> <i>Norma</i>	Einheit <i>Unit</i> <i>Unité</i> <i>Unità</i>	330 Click! 4,5 mm	
<p>Designböden <i>Design flooring /</i> <i>Sols design /</i> <i>Pavimenti vinilici</i> <i>modulari LVT</i></p> <p>330 Clickversion</p> <p>Transparente Nutzschicht inkl. PU-Vergütung <i>Transparent wear layer</i> <i>incl. PU treatment</i> <i>Couche d'usure transparente</i> <i>traitement PU incl.</i> <i>Strato di usura trasparente</i> <i>incl. trattamento PU</i></p>  <p>Fotofilm (Holz/Stein) <i>Printed film layer (wood/stone)</i> <i>Film décoratif (bois/pierre)</i> <i>Strato dec. (legno/pietra)</i></p> <p>Stabilisierungsschicht <i>Stabilisation layer</i> <i>Couche de stabilisation</i> <i>Strato di stabilizzazione</i></p> <p>Trägermaterial PVC <i>Support layer PVC</i> <i>Couche de fond PVC</i> <i>Materiale di supporto PVC</i></p> <p> Designböden sind phthalatfrei! <i>Design floors are phthalate-free!</i> <i>Les Sols Design sont sans phtalate !!</i> <i>I pavimenti design sono privi di ftalato.</i></p> <p> Indoor Air Comfort Gold Zertifikat <i>Indoor Air Comfort Gold Certificate</i> <i>certificat Indoor Air Comfort Gold</i> <i>certificato Indoor Air Comfort Gold</i></p> <p>REACH</p> <p> EN 14041:2004</p> <p></p> <p><small>* abhängig von Konzentration und Einwirkzeit / depending on concentration and time of exposure / dépend de la concentration et de la durée de contact / secondo concentrazione e durata</small></p>	Belagsart <i>Type of floorcovering</i> <i>Type de revêtement</i> <i>Tipo di rivestimento</i>	EN 649		PVC, heterogen <i>PVC, heterogeneous</i> <i>PVC, hétérogène</i> <i>PVC, eterogeneo</i>	
	Oberflächenvergütung <i>Surface treatment</i> <i>Traitement de surface</i> <i>Trattamento superficie</i>				
	Flächengewicht <i>Total weight</i> <i>Poids total</i> <i>Peso totale</i>	ISO 23997	g/m ²	ca. 7.910	
	Klassifizierung <i>Classification</i> <i>Classements</i> <i>Classificazione</i>	EN 685		23, 32	
	Gesamtdicke <i>Overall thickness</i> <i>Épaisseur totale</i> <i>Spessore totale</i>	EN 428	mm	4,5	
	Nutzschichtdicke <i>Wear layer thickness</i> <i>Épaisseur couche d'usure</i> <i>Spessore strato di usura</i>	EN 429	mm	0,40	
	Gefaste Kanten <i>Bevelled edges</i> <i>Lames chanfreinées</i> <i>Angoli smussati</i>				Microfase (Holzdekore) <i>Micro fiber (wood decors)</i> <i>Micro fibre (décors de bois)</i> <i>Microfibra (decori in legno)</i>
	Resteindruck <i>Residual indentation</i> <i>Poinçonnement résiduel</i> <i>Impronta residua</i>	EN 433	mm	≤ 0,1	
	Farbbeständigkeit <i>Colour fastness</i> <i>Tenue à la lumière</i> <i>Tenuta dei colori</i>	ISO 105-B02 Methode A (DIN 53388/9)	Stufe <i>level</i> <i>degré</i> <i>livello</i>	≥ 6 bei künstl. Licht <i>≥ 6 artificial light</i> <i>≥ 6 lumière artificielle</i> <i>≥ 6 alla luce artificiate</i>	
	Brandverhalten <i>Behaviour to fire</i> <i>Classement feu</i> <i>Comportamento al fuoco</i>	EN 13501-1		B _{f1-s1}	
	Rutschhemmung <i>Slip resistance</i> <i>Résistance au glissement</i> <i>Resistenza allo scivolamento</i>	DIN 51130 EN 13893		R10 DS	
	Trittschallverbesserung <i>Impact sound reduction</i> <i>Bruits d'impact</i> <i>Riduzione impatto sonoro</i>	ISO 10140-3	dB	ca. 11	
	Wärmedurchlasswst. <i>Thermal conductivity</i> <i>Conductibilité thermique</i> <i>Resistenza termica</i>	DIN 52612 EN 12667	m ² k/w	0,09	
	Elektrost. Verhalten <i>Electrostatic properties</i> <i>Charge électrostatique</i> <i>Comportamento elettrost.</i>	EN 1815	 kV	< 2	
	Ableitwiderstand <i>Vertical resistance</i> <i>Résistance électrique</i> <i>Resistenza elettrica</i>	EN 1081	Ohm	ca. 10 ¹¹	
	Chemikalienbest. <i>Chemical resistance</i> <i>Substances chimiques</i> <i>Resistenza chimica</i>	EN 423		beständig* <i>resistant*</i> <i>résistant*</i> <i>resistente*</i>	
Verschleißgruppe <i>Abrasion group</i> <i>Résistance à l'usure</i> <i>Gruppo usura</i>	EN 649		T		
Stuhlrolleneignung <i>Castor chair</i> <i>Sièges à roulettes</i> <i>Idoneità sedia a rotelle</i>	EN 425		ja, Typ W (EN 12529) <i>yes, type W (EN 12529)</i> <i>oui, typ W (EN 12529)</i> <i>si, tipo W (EN 12529)</i>		
Fußbodenheizung <i>Underfloor heating</i> <i>Chauffage par le sol</i> <i>Riscaldamento a pavimento</i>	EN 1264		geeignet, max. 27 °C <i>suitable, max. 27 °C</i> <i>approprié, max. 27 °C</i> <i>adatto, max. 27 °C</i>		



Bei Fragen zu unseren Produkten berät Sie Ihr INKU Fachhandwerker oder Fachhändler gern ausführlich. Ebenso können Sie uns im Internet unter www.inku.at besuchen und mehr über das vielseitige INKU Sortiment für schönes Wohnen erfahren.

Parkett | Melan | Teppich | Designböden | Tapeten | Wohnstoffe



INKU Jordan GmbH & Co. KG
IZ-NÖ Süd
Straße 3, Obj. M22
A-2355 Wr. Neudorf

www.inku.at
info@inku.at